

# Golden Rice

and other biofortified food crops for developing countries  
– challenges and potential



KUNGL. SKOGS- OCH LANTBRUKSAKADEMIENS  
TIDSKRIFT

Nummer 7 • 2008  
Årgång 147

*Publisher* Åke Barklund, Secretary General and Managing Director, KSLA

*Text-writer* Anna K Lindqvist, Terra Verba

*Graphic design/editor* Ylva Nordin

*Cover photo* Courtesy of the International Rice Research Institute (IRRI)

*Other photos* Ingo Potrykus p 16 • courtesy of the International Rice Research Institute (IRRI) pp 21, 77 • courtesy of the Golden Rice Humanitarian Board pp 34, 54 • J. V. Meenakshi p 44 • Patrick Eozenou p 47 top • HarvestPlus researchers p 47 middle • Kwasi Ampofo p 47 left • Yassir Islam p 47 bottom right • Anna K Lindqvist p 59 • Gary Monkvoid, Iowa State University p 64 • Pia Barklund p 84 • Dean Madden p 89

*Printed by* Ågerups Grafiska AB

*Printed in* January 2009

*Edition* 1000

*ISSN* 0023-5350

*ISBN* 978-91-85205-82-0

# Golden Rice

and other biofortified food crops for developing countries  
– challenges and potential

”I was hungry and you did not feed me”  
*Matt. 25:42*

Report from the Bertebos Conference in Falkenberg, Sweden, 7–9 September 2008.  
Key note speaker was Professor Ingo Potrykus (Switzerland), Bertebos Prize Winner 2007.

The Royal Swedish Academy of Agriculture and Forestry  
in cooperation with the Bertebos Foundation



THE BERTEBOS FOUNDATION was established in 1994 by Olof and Brita Stenström to promote training and scientific research within the food sector. The Bertebos Prize is awarded every second year for research of distinguished quality and practical use in Food, Agriculture, Ecology and Animal Health.

In 2007, Professor Ingo Potrykus, Magden, Switzerland, was awarded the Bertebos Prize for the development of methods for DNA transformation in plants.

Through the new techniques, hereditary characters such as disease resistance and improved quality have been added to crops such as wheat, rice and cassava. In the case of Golden Rice, Professor Potrykus and his team have engineered a rice variety to produce beta-carotene, the precursor of vitamin A. Lack of vitamin A causes blindness and death to millions of children in developing countries.

Professor Potrykus has been working tirelessly to resolve all the patent and legal obstacles that for several years have prevented the free use of Golden Rice by rice breeding institutes and small-scale farmers.

#### **Previous Bertebos Prize winners**

- 2005 Professor Piotr Kowalik, Gdansk University of Technology, Poland  
– Water dynamics in agriculture and forestry –
- 2003 Professor Erik Steen Jensen and Professor John R. Porter, KVL, Denmark  
– Soil biology and modelling of responses of agro ecosystems to their environment –
- 2001 Professor Donald Grierson, University of Nottingham, UK  
– Genetical engineering and food –
- 1999 Professor Wolfgang Witte, Robert Koch Institute, Wernigerode, Germany  
– Antibiotics in food and feed –
- 1997 Professor Christopher Polge, University of Cambridge, UK  
– Preservation of animal semen –

# Contents

FOREWORD.....☒	7
<b>PROGRESSING WITH GOLDEN RICE</b>	
Golden Rice—from idea to reality.....	11
Golden Rice as new varieties .....	17
Marketing research for optimizing Golden Rice cultivation and consumption .....	23
<b>GENE TECHNOLOGY CAN BENEFIT THE POOR</b>	
The potential of biofortification through genetic modification .....	31
Biotechnology in agricultural programmes in developing countries .....	37
Reaching the rural poor with biofortified crops.....	43
Impact assessment of Golden Rice in India .....	49
<b>DISCRIMINATORY REGULATIONS PREVENT PROGRESS</b>	
Explaining resistance to agricultural biotechnology .....	57
When is food safe enough? .....	63
Achieving risk-based regulation: science shows the way .....	69
Golden Rice and progress towards GMO-deregulation.....	75
<b>THE POLITICAL SITUATION FOR BIOTECHNOLOGY</b>	
Governing agricultural biotechnology in Africa.....	83
Biosafety in the EU context.....	87
Can bioscience support agricultural progress in developing countries? .....	93
<b>RESPONSIBILITIES FOR CHANGE</b>	
Appropriate science for an overpopulated planet.....	99
Extracts from the discussions.....	105
<b>ACRONYMS AND DEFINITIONS .....</b>	<b>110</b>
<b>SPEAKERS' PROFILES .....</b>	<b>111</b>

THE TWO-DAY BERTEBOS CONFERENCE "Golden Rice and other biofortified crops for developing countries—challenges and potential", was held in September 2008 at Elite Hotel Strandbaden in Falkenberg Sweden. The conference was chaired by Professor Sara von Arnold, the President of the Royal Swedish Academy of Agriculture and Forestry (KSLA), and comprised five sessions of presentations, each ending with a discussion, and finally a general conclusion and discussion:

**Case study with Golden Rice**

Professor Sara von Arnold, chair

**GMO technology can benefit the poor**

Former Swedish Minister of Agriculture Annika Åhnberg, chair

**Specific GMO-regulations prevent progress**

Professor Åke Bruce, Vice President of the Academy, chair

**The political situation for biotechnology in Europe and in developing countries**

Professor Peter Sylwan, chair

**Responsibilities for change**

Professor Mårten Carlsson, former President of the Academy, chair

**Conclusions from the symposium**

Professor Christopher J. Leaver

This report from the conference is structured somewhat differently according to the actual content of the presentations and discussions—to honour the speakers' intentions and to make it logical to the readers. The text reflects the opinion of the speaker, and not necessarily of KSLA or the writer of the report. The speaker is responsible for the facts and sources.

## Foreword

---

ÅKE BARKLUND

In June 2000, I listened to the Nobel Prize laureate Norman Borlaug giving a lecture at the World Agroforestry Centre, in Nairobi, Kenya. This foreword is summarizing his speech.

Science and technology are often attacked by environmental activists claiming that consumers are about to be poisoned by high-yielding agricultural innovations, including genetically modified organisms. How come that supposedly well-educated people are so badly informed about science? There seems to be a fear for research as such, increasing in parallel with new discoveries. The splitting of the atom some 60 years ago, and the nuclear war-threat after the Second World War, seem to have sparked this public fear and drawn in a wedge between scientists and laymen. The world is perceived as more and more “unnatural”, and science, technology and industry are to blame. Rachel Carson told us that man’s spreading of chemicals first kills the birds and later on will kill mankind.

These ideas about the perils of technology are not unfounded. Air and water have been badly affected by a wasteful industry, dumping its rubbish in back yards and dispersing it through chimneys.

Therefore, we should be grateful to the environmental groups for raising alarm about the pollution problems. Partly because of their efforts, legislation has been sharpened to improve water and air quality, nourish flora and fauna, control the handling of chemicals, safeguard the lands and protect biodiversity. But in almost all cases, at least in the developed world, the improvements of environment are greater than what mass media normally reports. How come the journalists are so averse to reporting on the achievements? One reason is that many scientists—against their better judgement—join the populist environmental bandwagon to receive research grants, thus suppressing positive environmental news and blowing the problems out of proportions.

What would the world look like without all the technological achievements in agriculture? If cereal yields in Asia would have remained at the same level as in the beginning of the sixties (930 kg/ha), we would have needed 600 million hectares more land of the same quality to reach the total 1997 tonnage. Obviously that extra agricultural land of good quality does not exist, and if it had been available, just consider the losses of forests, grassland and biodiversity that would have entailed producing this food using the old technology.

Today, we have the technologies to feed a world population of 10 billion people. The question is: will farmers and livestock keepers be allowed to use that technology? Extreme environmental elites seem to do whatever they can to stop the scientific progress. Small, well-financed, loud anti-science

groups are threatening development and the use of modern technology—biotechnology as well as advanced conventional agricultural technologies. While well-fed people in rich nations can afford such elite opinions and pay the higher price for organic food, the billion or so undernourished people in poor countries do definitely not have that possibility. New technologies—and not, as some environmentalists believe, the old-fashioned, low productive and very expensive agricultural methods—are the salvation for the poor.

The people working with agricultural gene technology have a great responsibility for explaining this situation. Scientists in general acknowledge this responsibility—but in spite of that, the resistance to using modern biotechnology is immense, something that indirectly kills millions and millions of people in the poor world. And that resistance is very much driven by people in the rich world.

Åke Barklund  
Secretary General, Managing Director  
Royal Swedish Academy of Agriculture and Forestry (KSLA)



# Progressing with Golden Rice

Golden Rice—from ideas to reality, p 11

Golden Rice as new varieties, p 17

Marketing research for optimizing Golden Rice cultivation and consumption, p 23



# Golden Rice—from idea to reality

PROF. INGO POTRYKUS

We are facing a situation where hundreds of millions of people are starving and suffering from micronutrient malnutrition. Using genetic engineering technology, we have the possibilities and potential to prevent this. But it doesn't happen because large parts of the society are against such help if it involves genetically modified organisms (GMOs).

Just like in the fairytale “The Emperor’s new clothes”, our society has been made to believe that GMOs are highly dangerous, by activists who are using public funds to protect us from this imaginary danger.

We have the responsibility to de-demonize GMOs; otherwise history will hold us responsible for death and suffering of millions.

## Malnutrition

Every day 24,000 people die because of poverty-based lack of food with adequate content of vitamins, minerals and essential amino-acids. In fact, the majority of the world’s poor try to survive on staple foods more or less deficient in these necessary micronutrients.

Rice, for example, is the basic staple crop for half the humankind. While rice is an excellent source of calories, its micronutrient content is very low. It does not contain any beta-carotene (provitamin A), which the body needs to create vitamin A. Dependency on rice as the predominant food source, therefore, necessarily leads to vitamin A deficiency (VAD), most severely affecting small children and pregnant women.

For the 400 million rice-consuming poor, VAD compromises the immune system, greatly increasing the severity of common childhood infections, often leading to impaired vision, in extreme cases irreversible blindness and eventually death.

Of course there are traditional interventions, such as supplementation, fortification, plant breeding, diet diversification, disease control and disaster relief, that with substantial financial investment do improve the situation. But although these interventions are effective, they are not effective enough. According to the World Health Organization (WHO), still 250,000 to 500,000 children go blind every year and around 2.2 million die due to VAD, mainly in Southeast Asia and Africa.

And for iron, zinc and other micro-nutrients, the deficiency problems are even larger.

## The idea

In the early 1990s, the team of Professor Potrykus at the Institute of Plant Sciences at ETH Zürich was working as other research laboratories on the prevention of pests and diseases. This was part of a concerted effort of

## HOW GOLDEN RICE CAN HELP – THE EXAMPLE OF BANGLADESH

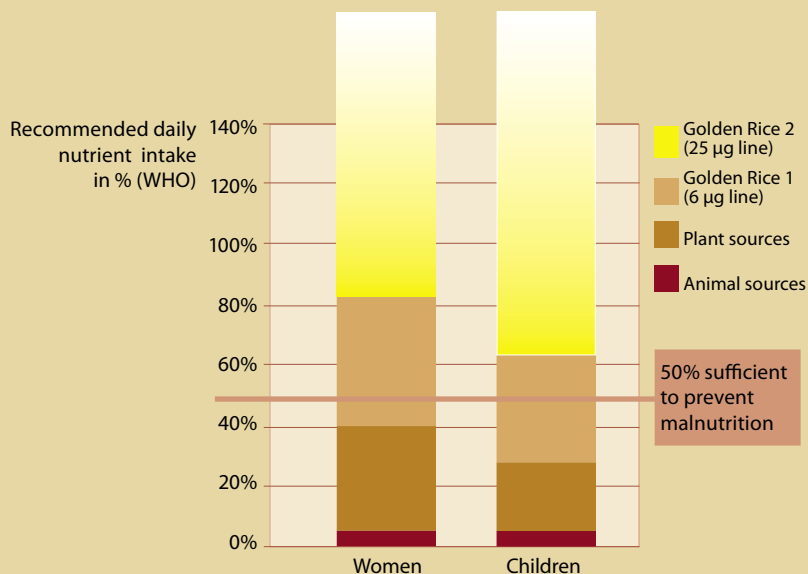

In Bangladesh, 80 percent of people's energy intake comes from rice. Women and children live far below the recommended daily allowance (RDA) of vitamin A intake and even below the critical 50 percent of RDA which is enough to avoid deficiency symptoms.

Shifting the diet to Golden Rice would raise the vitamin A level above the critical line for both women and children, even with varieties with the modest concentration of two micrograms provitamin A per gram endosperm. Using varieties with eight micrograms

provitamin A per gram rice would provide also societies eating less rice with sufficient vitamin A. There are several strains of Golden Rice making it possible to adjust the level of provitamin A according to different societies' needs.

Overdosing the provitamin A is not possible, because the human body carefully regulates how much of it is being converted into vitamin A (which can be overdosed).

developing and using agro-biotechnology in contribution to food security in developing countries. There were ongoing PhD-projects with rice, wheat, sorghum, forage grasses and maniok, aiming at traits such as insect-, fungal- and viral pest resistance. The laboratory was equipped for and experienced in gene transformation technology.

This was the time when Professor Potrykus got the idea of improving the content of micro-nutrients in food crops. If rice was made to contain vitamins and minerals in the grain, malnutrition should be substantially reduced. The crop would be grown by those in need and the seed could be passed on from farmer to farmer.

ETH Zürich appointed two PhD students to try with provitamin A (Peter Burckhard, 1992) and iron (Paola Lucca, 1994). At the same time, Dr Peter Beyer at the University of Freiburg studied the regulation of the terpenoid biosynthetic pathway in the model plant daffodil, involving provitamin A as an essential component. This work perfectly complemented the plans of Ingo Potrykus and his team.

Although there were funds to secure the two PhD-projects, it was important that the Rockefeller Foundation decided to support both research laboratories, despite the fact that the scientific community had very good reasons to consider the idea totally unfeasible. The concept, on which from then onwards Peter Beyer and Ingo Potrykus collaborated, was: *“Would it be possible to engineer the biochemical pathway of provitamin A into the rice endosperm, to make the rice grain produce enough provitamin to reduce vitamin A deficiency of rice-dependent societies?”*

### A scientific challenge

Until then, only single gene transfers had been done. Here, the entire biochemical pathway, from the last detectable precursor, geranylgeranyl-pyrrophosphate, to beta-carotene had to be engineered. Genes for four missing enzymes plus a selectable marker gene had to be isolated and transformed into the rice genome. There were several unknown components. How would the endosperm cell react? Would the gene products (the enzymes) find membranes to integrate and function? Would there be any mechanism to accumulate provitamin A in case of success? Would the hormone physiology be disturbed by channelling key precursors into a new pathway? Etc.

After eight years of hard work, the dream became reality. It was indeed possible to produce a missing vitamin in rice to help poor

people.

The final experiment—criticized in the peer review process because it involved several parameters not possible to control—was an Agrobacterium-mediated co-transformation experiment with the four genes in two Agrobacterium strains plus the marker gene in one of them<sup>1</sup>. Surprisingly, all plants with yellow endosperm were perfectly normal and fertile and the best ones contained 1.6 micrograms provitamin A per gram of rice.

Nowadays, Golden Rice can be produced with just two genes—one from maize and one from a soil bacterium, and providing up to 30 micrograms provitamin A per gram endosperm. And there is no marker gene left.

The breakthrough caused a lot of excitement in the scientific community and in media. Golden Rice could save numerous lives at minimal costs and was thought to be used as soon as possible. It was expected that in a couple of years—as long as it takes to breed a variety from a new trait—the rice would be in the farmers’ fields.

Now we have 2008 and it will take until 2012 until the invention can be handed out to the farmers. The hurdles and lessons learnt have been numerous: finding financial support for developing the invention into a usable product, coping with patent and regulatory requirements, getting the product to the market, and resisting the overwhelming negative attitudes on GMOs from politicians, development organizations, bureaucracy and the so called “enlightened societies” The outstanding hurdle and the main cause for ten years’ delay is GMO-regulation.

### Finding support

The first complication was that there is no mechanism in the public domain to develop a scientific discovery into a humanitarian pro-

---

1. Engineering provitamin A (beta-carotene) biosynthetic pathway into (carotenoid-free) rice endosperm. By Xudong Ye *et al.* Published 2000 in *Science* 287: 303–305.

duct. Normally, product development is taken up by industry, but when no financial return can be expected, there is no incentive for them.

As genetic modification technology had been used, there were also regulatory requirements and intellectual property rights involved. The public sector is not set for this kind of tasks and no public institution had the experience of developing a genetically modified product. There was not even any financial support from the public domain, the most disappointing case being WHO with the mandate and funding to reduce vitamin A malnutrition. It turned out that no institution depending on European donor countries dared to support work in which GMOs are involved, other than so called "bio-safety research". Solutions for humanitarian problems with the help of biotechnology were taboo.

Left with no other option, the scientists asked the industry to help out. Therefore, the key driver became a deal with the private multinational Syngenta, where Dr. Adrian Dubock organized support for this humanitarian project in exchange of the rights for commercial exploitation of the invention.

Dubock manoeuvred through the numerous patents involved. When Syngenta after some time decided to abandon the idea of a commercial Golden Rice, he convinced the company to donate all achievements of the company lab to the humanitarian project. And he taught the team what it means to develop a product.

Naively, one would assume that a new crop variety with additional advantages for both consumers and farmers would sell itself among the needy. But that is far from the reality. Besides fulfilling the regulatory requirements and breeding the trait into local varieties, additional skills are required for the complex challenge of social marketing.

## Regulation

Had Golden Rice not been genetically modified, it would have been in use since 2002. Now it is taking ten years longer, causing up to 400,000 unnecessary deaths in India alone, for no other reason than the regulatory system established world-wide with financial support from the United Nations.

If there hadn't been support from the private sector, which is experienced in the regulatory requirements and intellectual property rights, Potrykus and Beyer would have given up and Golden Rice would have been no more than an academic exercise.

Intellectual property rights, often considered the outstanding hurdle, turned out not to pose a major problem. Although there were 70 patents involved, freedom to operate was achieved within half a year.

For the regulatory requirements, however, an entire scientific team had to carry out hundreds of costly experiments to get the slightest chance for the application to be accepted.

The project lost two years in deleting the selectable marker gene, even though a host of scientific data has proved it to be of no harm. The screening of streamlined integration of the gene is possible but requires the production of thousands of independent transgenic events by repeating the same experiment again and again. The selection of a clean event took another two years. An unbelievable experience was the transfer of seed material between breeders; it took more than two years to get a batch of seed from the Philippines to a breeder in Vietnam. There is a strict sequence of numerous experiments to be done in close chambers like greenhouses. Even though no ecologist around the world can come up with a hypothetical risk of Golden Rice, there have been years of waiting for permission to do experiments in the field. And so forth. Table 1 shows some of the require-

Table 1. The regulatory dossier requires a minimum of seven years for a team of specialists and a financial investment of around USD 15 million.

Deletion of selectable marker	unjustified	2 years
Screening for streamlined integration	unjustified	2 years
Screening for regulatory clean events	unjustified	2 years
Protection against liability problems	justified	1 year
Transboundary movement of seeds	unjustified	2 years
Obligatory sequence greenhouse-field	unjustified	1 year
Permission for working in the field	unjustified	2 years
Requirement for one-event selection	unjustified	2 years
Experiments for the regulatory dossier	partly justified	4 years
Deregulation procedure	partly justified	1 year

ments and the estimated time for each one. Fortunately some of them could run in parallel.

The key argument for regulation is the notion that the technology is leading to “uncontrolled and unpredictable alterations of the genome”. And that is true, but not at all a novelty beyond hundreds of years of traditional plant breeding. The technical terms include mutations, recombinations, deletions, inversions and translocations—alterations so drastic that they sometimes can be seen in the microscope. The only thing breeders have done to cope with this, has been to select those individuals from the offspring which carried the desired new trait. And all what mankind has been doing has been to eat these plants, without regulation.

So what is new with GMOs? Only that the genetic modification is minor, precise, more predictable and far better studied than that from traditional plant breeding.

Therefore, there is no scientific justification for specific GMO-regulation. If anything, it is time to shift to regulation of traits instead of technology!

## Opposition and negative attitudes

We have a wealth of scientific data from over 25 years, all of which conclude that there is no specific risk associated with transgenic plants. We have the results from regulatory oversight, leading to release of transgenic plants to the environment and for consumption. We have an unprecedented track record of safe use of transgenic plants in countries around the world and on over 100 million hectares of crop land. We have statements from national and international academies and government commissions, all agreeing that transgenic plants are at least as safe as non-transgenic ones.

Still, our societies maintain at large that it is better to trust anti-GMO campaigners’ claim that transgenic plants pose uncontrollable risks to the environment, to the consumer, and to the society at large.

There is a powerful, self-serving network of non governmental organizations established around the world, which, with massive support from governments and media, maintains a self-reinforcing feedback circle in an “Emperor’s new clothes” trick of our time.

## De-demonizing

In the early 19<sup>th</sup> century a Thai princess celebrated her 18<sup>th</sup> birthday. She fell into the palace pond and drowned in front of hundreds of guests. Nobody helped her out of the water. Why? It was taboo to touch a member of the royal family, because they were believed to be divine.

In the 21<sup>st</sup> century up to 500,000 children become blind and 2.2 million die every year from vitamin A malnutrition. This could be

prevented. However, similarly, genetic modification is taboo for our “enlightened” societies.

Humanity has the responsibility to take care of those who cannot take care of themselves. Therefore, we should resolve this rather unnecessary problem of condemning the technology instead of using it to help the poor people. We have the responsibility to de-demonize GMOs. If not, history will hold us responsible for a crime against humanity.

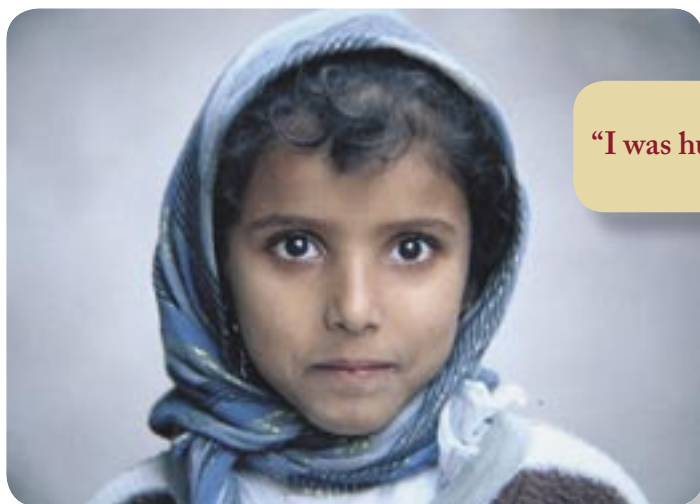

**“I was hungry and you didn’t feed me.”**



## Golden Rice as new varieties

DR. PARMINDER VIRK

Golden Rice is now a breeding project transferring the provitamin A trait into the most popular mega-varieties in South and Southeast Asia. The utilization of molecular markers based on genome sequence information in rice is helping to design efficient breeding strategies, accelerating the development of Golden Rice.

The first contained outdoor trial was performed in 2008. Field trials will begin by 2010/2011 and by 2012/2013 the Golden Rice is expected to be released to farmers.

As all others working with the Golden Rice breeding project, Parminder Virk describes the excitement: "My dream is to see the Golden Rice in the farmers' fields".

### The importance of rice

Rice is the world's most important staple crop. Ninety percent is grown and consumed in South and Southeast Asia. In some areas more than half a kilo rice is eaten per person per day, thereby making up the larger part of the daily energy intake (figure 1). In Asian countries, such as Myanmar (Burma), Bangladesh and the Philippines, it is more or less the only food for many people; rice consumption is as high as 990 grams per day per person and most of the energy intake comes from rice.

As with many other staple foods, rice contains low levels, sometimes none, of important micronutrients. For example, polished rice contains around 20 percent of the daily requirement of zinc, tiny amounts of iron and folate, and is more or less deficient of vitamin A and vitamin C.

Thanks to the bioengineering research at the University of Freiburg and Swiss Federal

Institute of Technology (ETH) in Zürich, already in 2000 the technique of making rice produce provitamin A in its endosperm was perfected. From initially using four genes, now only two have proven to be enough to provide sufficient levels of provitamin A in the rice endosperm to make an impact on human health.

### Now a breeding project

Together with other institutions in India, Vietnam and the Philippines, the International Rice Research Institute (IRRI) was given the task of transferring the Golden Rice genes into popular rice varieties grown in South and Southeast Asia. At this stage, Golden Rice is primarily a breeding project.

The initial research in Europe and the United States was done on Japonica rice. As Japonica doesn't grow well in South and Southeast Asia

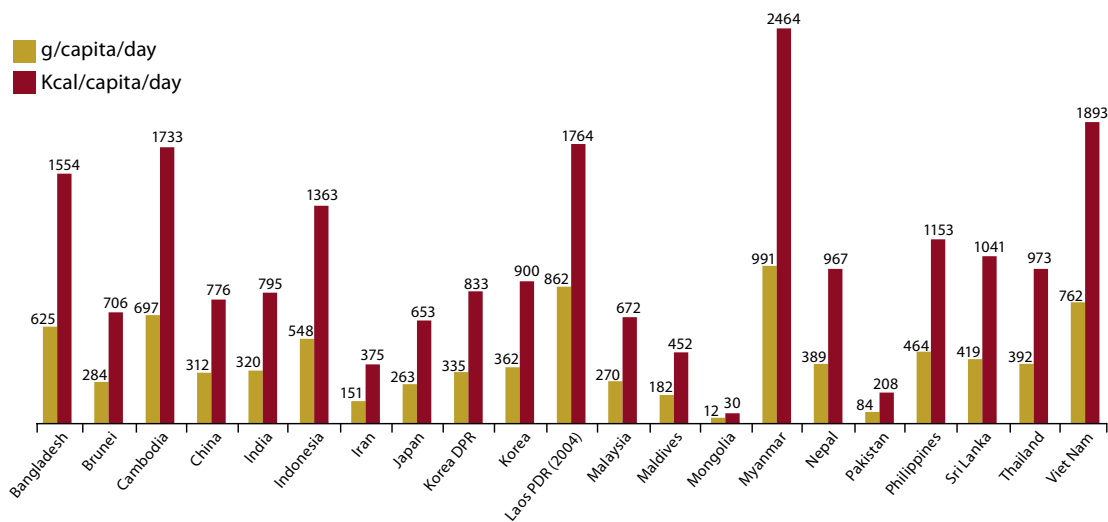

Figure 1. Rice consumption in Asia (source: FAOSTAT).

and is not liked by consumers, the Golden Rice loci must be transferred into Indica rice of popular Asian varieties.

Nine events were brought to Asia:

- Three events of the Cocodrie variety called Golden Rice 1 (GR1), where the phytoene synthase gene is taken from daffodil giving carotenoid levels of up to eight micrograms per gram rice.
- Six events of the Kaybonnet variety called Golden Rice 2 (GR2), where the gene instead comes from maize and gives as much as 25 micrograms beta-carotene per gram rice.

To keep the regulatory costs down, out of the nine events only one will eventually be released.

In this first phase, IRRI is transferring both GR1 and GR2 events into four varieties:

- IR64 and IR36, two mega-varieties with broad Asian coverage.
- BR29, the most popular and high-yielding *Boro* rice variety in Bangladesh.
- PSB Rc82, which right now is the most popular variety in the Philippines.

In India, Golden Rice Network centres are transferring the Golden Rice events into six popular varieties. In Vietnam, Cuu Long Delta Rice Research Institute (CLRRI) is working on four Vietnamese rice varieties. In the Philippines, the Philippines Rice Research Institute (PhilRice) is introgressing the events into two varieties.

In the years to come the work will continue also in other countries.

### Transferring the events

The process of transferring Golden Rice events into the local varieties is done through conventional backcrossing schemes, speeded up with marker aided backcrossing.

In conventional backcrossing, the donor variety with the desired new trait is crossed with the receiving variety, to make an offspring that in the end should be almost exactly the same as the receiving variety except for the new trait. After six generations of repetitive backcrossing and visual selection, the plants will have nearly 99 percent of the original genome reconstruc-

tion but still slightly more than one percent from the donor, including the desired new trait.

With the marker aided backcrossing, though, DNA based markers act as landmarks on each of the chromosomes. Such marker aided backcrossing is used to improve the efficiency and

precision of conventional backcrossing, and has two advantages:

- It minimizes the negative linkages from unimproved sources.
- It accelerates the whole process.

Within two or three backcrosses it is possible to get nearly 100 percent of the genome reconstructed (figure 2).

With conventional breeding, even after 20 backcrosses there will always be a slight linkage drag from the donor chromosome remaining, while if using marker assisted selection with adjoining markers around the locus, the same results will be achieved within three backcrosses. This shortens the time of developing new varieties from five or six years down to only two to three years (figure 3).

The marker aided backcrossing offers the prospect of rapid conversion of a mega-variety or local popular variety into a new variety with the same characteristics except for the new trait conferred by one major gene.

Thankfully, DNA marker resources for rice are available also in the public domain. For example, simple sequence repeats (SSRs) or microsatellite markers are available on the website, where you can se-

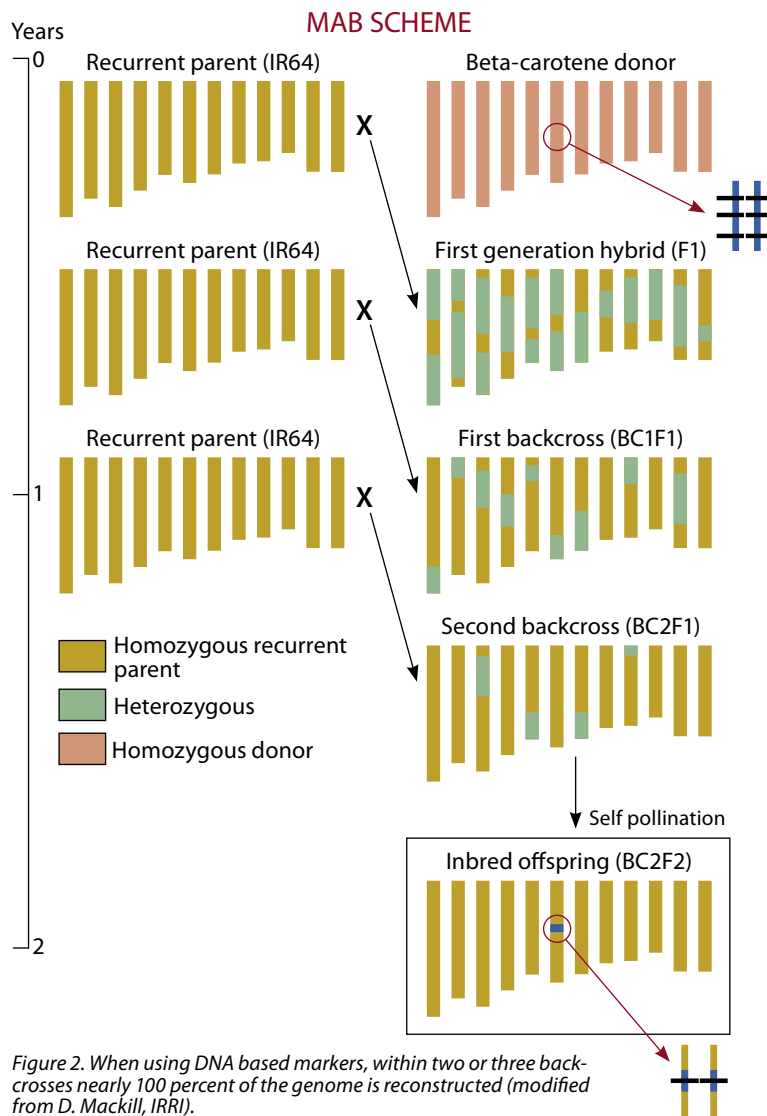

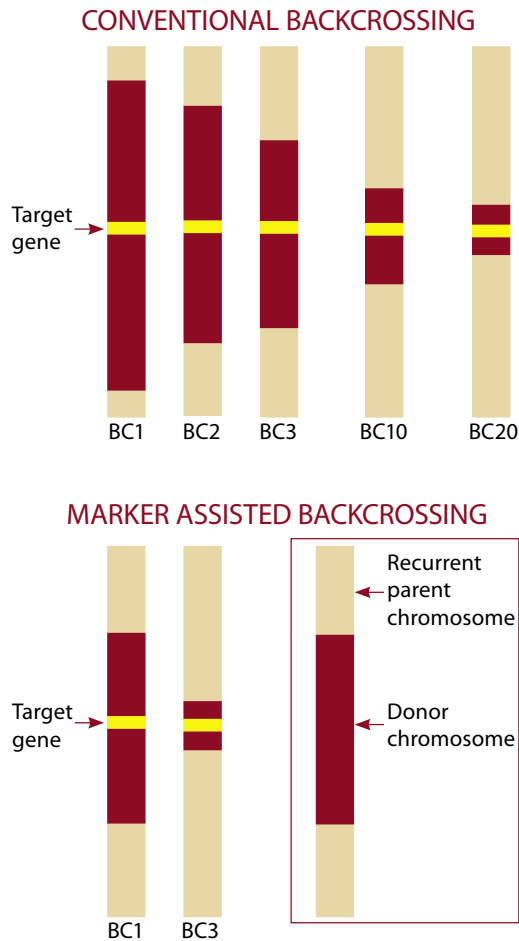

Figure 3. With marker assisted backcrossing, the time of breeding may be reduced from five or six to two or three years (courtesy: D. Mackill, IRRI).

lect the marker of your choice. As they are very polymorphic, they can be used for driving the backcrossing programme. There are more than 18,000 markers available and therefore marker density across the genome is not a problem.

With Golden Rice, backcrossing is done in three generations, starting off with 500 to 600 plants and after the third generation end-

ing up selecting 20 progenies, which will go for agronomic evaluation starting 2009.

The next generation DNA markers are called Single Nucleotide Polymorphisms (SNPs). They are amenable to automation; they can speed up the process even further—evaluate data in a few days instead of weeks; and also they are available in large numbers.

### Progress in the Philippines

In the Philippines, both IRRI and PhilRice (the national agricultural research and extension system) are working on transferring the golden trait from the high beta-carotene prototypes into popular Asian rice varieties.

While the breeding project is ongoing, other tests are carried out concurrently. Storage and cooking stability as well as bioavailability are studied at the advanced institutions not only in Asia but also in the EU and the US. There are continuous interactions with the national regulators—the National Committee of Biosafety in the Philippines (NCBP), and submission of data for regulatory reviews. Nutrition experts are working out which levels of beta-carotene that will be needed in rice, as well as advocating for Golden Rice at the public health institutions. Marketing researchers are studying how to deploy for impact.

The first outdoor trial started in 2008 with one GR1 event. Further outdoor trials from GR2 events will start with the variety BR29 in 2009, and with the varieties IR64, IR36 and Rc82 the trials will be carried out in 2010 and 2011.

Eventually, after this whole process, the Golden Rice will be released to the farmers. And as all others working with the Golden Rice, Parminder Virk exclaims: “My dream is to see it in the farmers’ fields”.



*April 2, 2008*

The National Committee of Biosafety in the Philippines (NCBP) overlooked the planting in April. Twenty lines of Golden Rice 1, event 309, were grown off-season, surrounded by rows of maize, open water and a fence.

The first outdoor trial of Golden Rice in Asia took place in the Philippines in 2008.



*May 30, 2008*



*June 13, 2008*

Unfortunately, one week before harvest, a typhoon destroyed the field, turning the whole exercise into a rehearsal for future.



*July 10, 2008*



# Marketing research for optimizing Golden Rice cultivation and consumption

DR. ADRIAN DUBOCK

The private sector has skills that public sector projects can benefit from. One of them is the marketing approach now being applied to Golden Rice. When the seeds are available for distribution to growers, there has to be marketing and distribution systems in place, to ensure that the crop will be grown and there is consumption of the product, so the people it is designed for will benefit from it.

As Golden Rice is developed for marginalized members of society without purchasing power, the marketing gets extra complicated. How can demand be generated amongst those who are to benefit? This paper presents the marketing research just starting for Golden Rice, and explains why this is necessary.

## Private sector skills

Developing GM crops is commonly too demanding for public sector institutions, even without considering the time and costs for fulfilling the regulatory requirements. There are a lot of initiatives on biofortified crops around the globe, but unfortunately very few are launched due to various constraints to product introduction. Apart from regulatory requirements, there are social and political attitudes to overcome. Difficulties are magnified by lack of money for the necessary research and/or lack of staff for management and marketing. Product supply may also present obstacles.

Figure 4 gives an overview of how private companies work to create successful agricultural innovation platforms for new products. Without thoroughly preparing for, and success in, the deployment phase of a new product, none of the research and development activities are useful.

Golden Rice is now in the stage of lead transformation event selection. Nutritional trials have been done to understand how much provitamin A is needed in the rice. Based on that, the number of events will be reduced to only one that can deliver the right amount of provitamin A also after storage. The breeding and variety development has begun and the deployment phase has to be prepared for.

When preparing for marketing, it is important to remember what Golden Rice is designed for. Golden Rice is very different from most other genetically modified crops being placed on the market. It is not for the profit of multinational or other private companies and not for wealthy consumers in industrial countries, and there may not be an economic benefit for the grower. Golden Rice is purely a consumer product for the poor in developing countries, to reduce mortality and morbidity due to vitamin A deficiency.

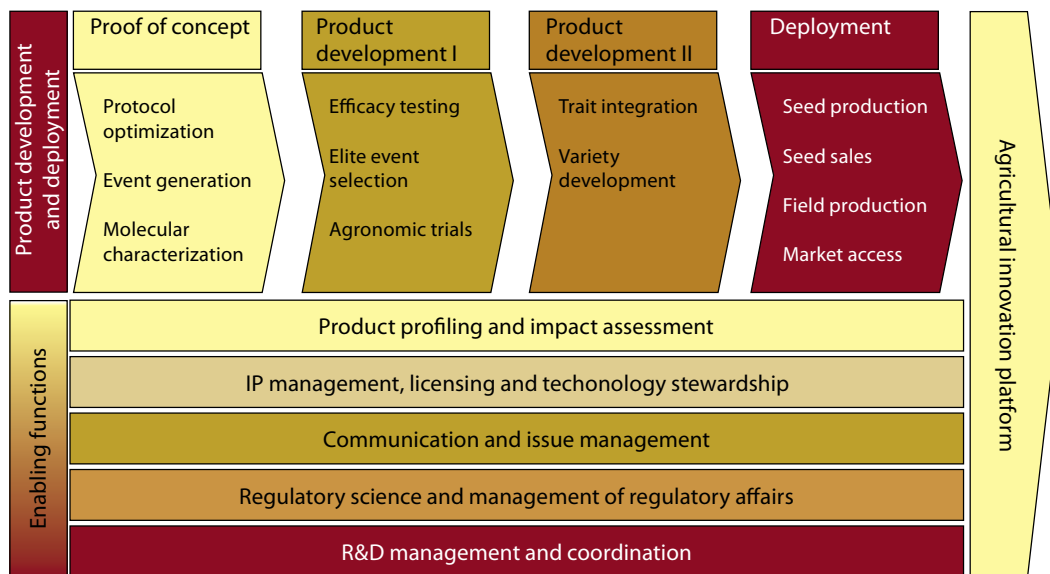

Figure 4. While the private industry develops a new project, several enabling functions run alongside to prepare for a successful deployment of the product.

### Three elements working together

For the marketing to be successful, three elements have to work together: the consumption, the cultivation and an enabling environment.

The main task is to create consumption demand. This is about modifying behaviour of consumers, which is the same as social marketing, because we are trying to market a product using the same sort of techniques used for common consumer goods, except that this product is not for the profit. (In fact, the license term says that there must be no charge for the trait.)

But the growers must grow before the consumers can eat, so both the growers and consumers must be influenced at the same time. Normally growers cultivate something because there is an economic benefit to it. Now, we have to induce them to grow.

The market placement must be underpinned by an enabling environment. Politicians,

governments, the value chain and media need to be supportive for the cultivation and consumption of the biofortified crops to take place. Local non-governmental and community based organizations must be helpful. Therefore, a “public and governments affairs strategy” will look into who needs to be influenced and what the enablers can do to reach our purpose.

### Marketing research

The relationship between market research, marketing research, test marketing and marketing is shown in figure 5. In this case, the marketing research is about cheaply finding out which are the motivators and demotivators for the consumers that Golden Rice is designed to assist. It is also about understanding the communication channels most likely to be effective in delivering messages to them in a cost-effective way.



The marketing research is attitudinal and qualitative. It doesn't give hard and fast answers; there is no right or wrong. It is looking for patterns, trying to understand what product characteristics will appeal and not appeal to the consumer or the grower.

In terms of influencing consumers, we want to know what the consumers need and what appeals to them. The Golden Rice is yellow, and it is a GMO. Do they understand it, and is that important? What would motivate them to purchase it, cook it and consume it? And how can these messages be communicated?

And how to cause the growers to grow Golden Rice? Possibly in the rural areas, family welfare may be seen as a proxy economic benefit. But we don't know that.

Then we need to find out who influences growers and consumers (who often, in developing countries, may be the same). Where do they get their information from? Is it from the clinic,

the neighbour, the radio, or where? Who do they believe; who is credible for them? This will give the knowledge how to communicate through appropriate channels for that population.

There are various marketing research tools that will be used to get to understand all these questions. These tools are well developed in the private sector and used by consumer goods companies to market their products. They are logical, pragmatic, practical and the lowest cost for the result.

### Focus groups discussions

The principal tool for the marketing research will be focus group discussions with story boards (figure 6). This valuable tool is simple to use, but it needs a thorough preparation.

The story board development is critical. Each concept to be investigated should be turned

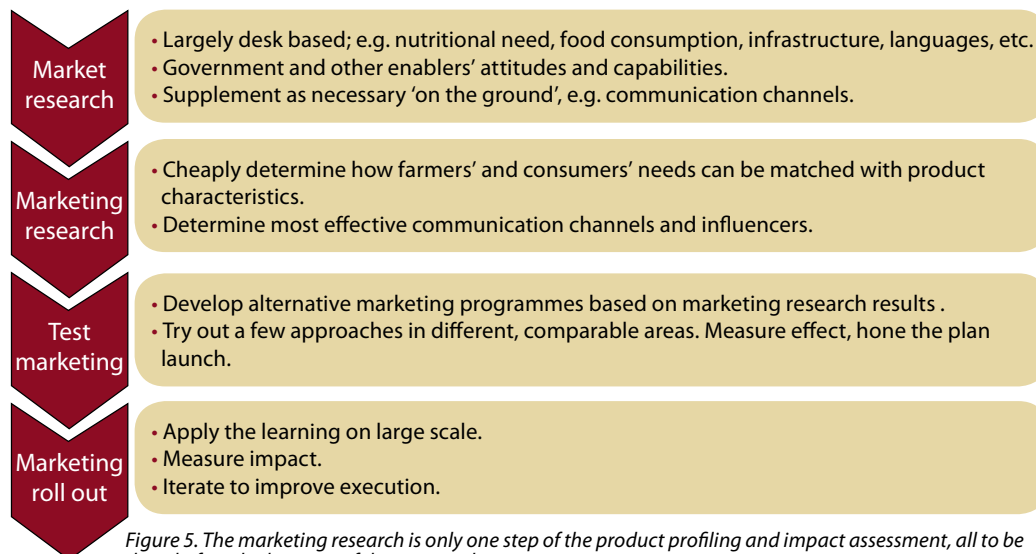

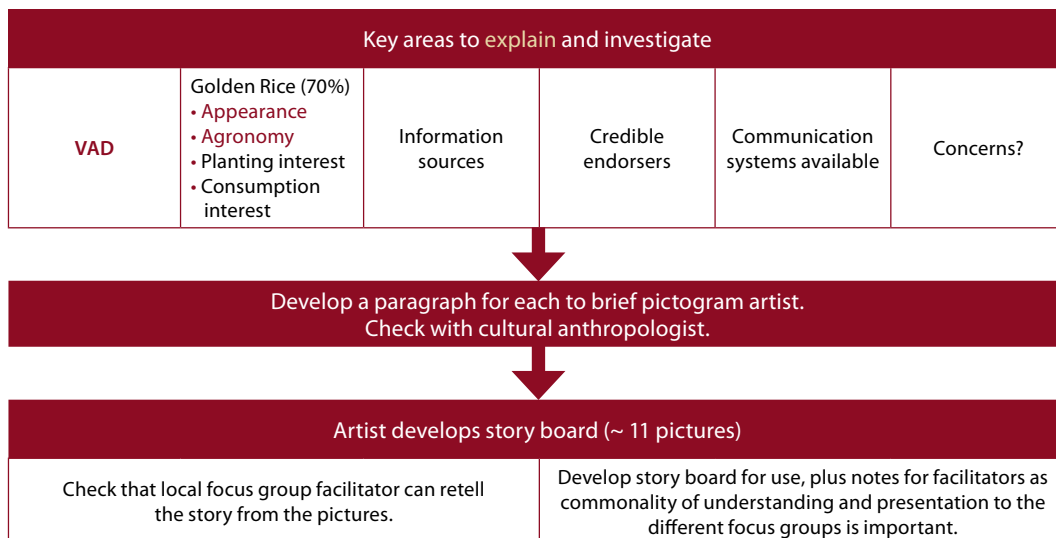

Figure 6. Focus group discussions with story boards will be the marketing research tool for Golden Rice, possible to use in different language areas.

into a single word. For each word, a paragraph should be developed, and for each of those a pictogram, comprehensible for each culture to tell the story and stimulate discussion. Cultural anthropologists, sensitive to those cultures and their knowledge base and value systems, must check and make sure the concepts are understandable to the target population. As the work will be done in different areas, there will be a set of pictograms tailored for each culture group.

We also need to make sure that the results can be aggregated in a comprehensible manner and tell whether there are patterns emerging.

It is important to get uniform discussion groups. And to get the right people to be facilitators, those who can communicate in local dialect, and without being authoritative can lead the discussions without leading the participants in any direction but stimulate from them their thoughts in the areas we want to investigate.

The goal is to understand what would motivate, or demotivate, the farmers and consumers about planting and eating Golden Rice.

Besides the story boards, there is a range of marketing research tests commonly used for fast moving consumer goods (FMCG) (table 2). Some of those could be used in the focus groups. But as the Golden Rice is a GMO before regulatory clearance, people cannot taste and eat the product, nor can they take away and cook or grow Golden Rice. Prior to registration, these facts have to be explained instead of letting the people try. And after marketing roll-out, there has to be a closer follow-up.

### The six P's

The work will start in the Philippines in 2009 and will then continue subsequently in India, Bangladesh and Vietnam. In the high rice-consuming regions of each country with prevalent VAD, three areas will be chosen, each of 50x50 kilometres, where twelve focus groups with ten to twelve persons per focus group will be selected, in total giving about 400 opinions per country.

Table 2. A range of marketing research tests can be used on Golden Rice.

Taste	Blind test of completing alternative foods
Look	See the different appearance
Menu	How would they use it in daily menus
Preparation	Allows cooking experience
Purchase	Reaction to different prices in simulated market
Usage	Measuring usage over time (a month?) if left on their own
Planting	How farmers would plant it
Market	Temptation to see on the market rather than using it
Brand	Impact of name and/or logo
Positioning of benefits	Best acceptance or communication of the story to navigate the adoption process

There aren't any established marketing agencies operating in those remote areas. Nobody is doing consumer marketing there, because there is no money to buy consumer goods. So everything has to be set up from scratch.

The institutions and individuals involved will vary according to local conditions. Generally it is intended to use MBA students from the Asian Institute of Management as managers of the process, and locally acceptable other collaborating members, such as NGOs operating in the respective areas for the additional logistical needs. The facilitators will be given training in the utilization of the story boards in a standardized manner to elicit the views of the respondents without leading them.

As soon as the product is registered, the results will be validated with real materials, the impact of communication and messages must be measured and refined to increase the uptake further. Hopefully, some patterns will soon ap-

pear, saving us from having to do this work in all countries where Golden Rice will be introduced.

Based on the results, in 2011 there should be a test market roll-out to try one or two different approaches. Bringing together the three elements of enabling environment, cultivation and consumption, it would then be possible to get demand created by doing social marketing through the "six Ps" that conventional marketing concentrates on:

- Getting the *product* right.
- Knowing the *people*.
- Finding the best *place* for distribution.
- *Positioning* the product correctly so it becomes acceptable for the people.
- Getting the *price* right—there shouldn't be any difference between this and normal rice.
- Knowing how to *promote* the product, that is how to communicate the message.

#### Read more

Poorer nations turn to publicly developed GM crops. By J.I. Cohen. Published in 2005 in *Nature Biotechnology*, vol. 23 No. 1:27–33.

Nutritionally improved agricultural crops. By M. Newell-McGloughlin. Published in 2008 in *Plant Physiology*, vol 147: 939–952.



# Gene technology can benefit the poor

The potential of biofortification through genetic modification, p 31

Biotechnology in agricultural programmes in developing countries, p 37

Reaching the rural poor with biofortified crops, p 43

Impact assessment of Golden Rice in India, p 49



# The potential of biofortification through genetic modification

PROF. PETER BEYER

The progress in gene discovery has been extraordinary, and the knowledge on pathways for biosynthesis of human micronutrients has grown tremendously. A main reason is that all organisms share a good proportion of their genes and metabolic functions, making it possible to draw conclusions from one species to another, and to do the research on those organisms with shortest life cycles.

Even though plants are able to synthesize all nutrients needed for humans, the parts that we eat are often poor in vitamins and minerals.

Biofortification is a cost-effective means to fight micronutrient deficiencies. But to do this with conventional breeding is not always an option. Some species are difficult or impossible to breed and others have too small trait variation. In those cases genetic modification offers an alternative, that with modern knowledge holds an enormous potential.

## Chemical factories

Plants can be seen as extremely versatile chemical factories. A single leaf of *Arabidopsis*<sup>1</sup> contains not less than 2,000 different substances, and the entire plant kingdom can produce 200,000 or more different natural chemicals.

Some of these compounds are important for humans, such as vitamins and trace minerals. Considering the amounts of chemical compounds in plants, there is no problem for humans to live their whole lives as vegetarians. Plants can provide everything that is needed.

However, these micronutrients are unevenly distributed between plant species, and also amid different tissues in one plant. Leaves often

contain all necessary micronutrients, while in the specialized storage tissues of grain, roots and tubers—the parts that make up most staple foods—the biochemical diversity is small.

For example in the rice grain (the endosperm), the micronutrients iron, folate, provitamin A and vitamin E are more or less absent, while in the rice leaf, which we don't eat, they are all there. Unpolished rice with its husk contains small amounts of these nutrients but not enough to meet the body's requirements.

To live well, it is therefore necessary to diversify the staple food diet with meat and leafy vegetables, or at least with beans. Or fortify the food with the missing substances.

1. *Arabidopsis thaliana*, (common name in English: rock cress, and in Swedish: backtrav) is a small herb related to cabbage and mustard, widely used in research on plant genomics. It was the first plant to have its entire genome sequenced.

## Genetic modification where needed

Biofortification—making plants produce the necessary micronutrients in the storage tissues—through conventional breeding is often, but not always, possible. Some major food crops like banana and cassava cannot be easily bred, and others, like rice, don't have enough variation of the traits to make breeding possible.

Banana (plantain), for example, is the staple food in more than 50 countries; in Uganda consumption is amounting to 220 kilograms per person per year. It contains low levels of vitamins and minerals (table 3). The species has not been genetically improved for thousands of years, and is constituted by sterile triploids selected from the wild, making conventional breeding extremely difficult.

Cassava ranks number five among human staple foods; in sub-Saharan Africa number one because of its ability to provide food security. But the micronutrient content is low. The tuber is vegetatively propagated, with low varietal recovery and long breeding cycles, and therefore conventional breeding would be difficult.

Other species, such as rice, don't have adequate trait variability for improving micronutrient levels through conventional breeding. The variation in iron and zinc might be sufficient, while for provitamin A and folate it is too low (table 3).

For all such species, recombinant DNA (rDNA) modification offers an opportunity to

still improve the nutrition contents, which should be recognized as a viable alternative to classical breeding and a complement to other fortification interventions.

Golden Rice represents the first example of biofortified foods made possible by the application of rDNA technologies. In this case breeding was not an option as beta-carotene (provitamin A) does not exist in the rice endosperm.

## Progressing gene discovery

Just like any other technology, be it conventional breeding or organic farming, rDNA modification depends on certain tools and the understanding how to use them. For gene modification the tools are:

- Cloned genes together with molecular knowledge of pathways (both for biosynthesis and biodegradation).
- Knowledge on rate-limiting steps (i.e. the bottlenecks of the pathways).
- Knowledge on pathway regulation (e.g. enzyme feedback regulation).
- Promoters (elements) conferring tissue-specificity of expression.
- Plant transformation protocols (tissue culture and plant regeneration).

We have come to know a lot about genes and gene functions. The discoveries continue with a fantastic velocity, and all new knowledge stems

Table 3. The content of some micronutrients in the endosperm of banana, cassava and rice.

	Banana	Cassava	Rice
Beta-carotene/provitamin A ( $\mu\text{g/g}$ )	2.7	3–5	0
Iron (ppm)	2.6	5	1–8
Zinc (ppm)		1	16–28
Vitamin E ( $\mu\text{g/g}$ )	1	1	0



from model organisms with wholly sequenced genomes.

Imagine being a scientist, just having sequenced a plant genome and done the bio-informatic analyses, and you will end up finding that two thirds of the genome are nearly the same as in other plants and one third very similar to all other organisms. This reflects the *metabolic unity* between animal, plant and bacteria kingdoms, and allows vast exchange of information on research done on different organisms.

For example, gene function elucidated in yeast, helps to clarify the gene function also in plants, because there is a strong likelihood that it is similar, or even identical in function. Or, a carotenoid gene taken from a plant will work equally well in *E.coli*, and through using the bacteria, the biochemical analyses can be made much faster.

Also because of this unity between organisms, *model systems* have become extremely helpful in increasing the knowledgebase; in characterizing genes; elucidating loss of function, gain of function, etc. These are the reasons why the growth of information and knowledge is so fast.

Among this vast knowledge of genetics, the novelty in *nutritional genomics* lies in the focusing on those components and pathways that are important for human nutrition.

### Pathways, bottlenecks and shortcuts

Pathways of enzymes can be compared with rail systems.

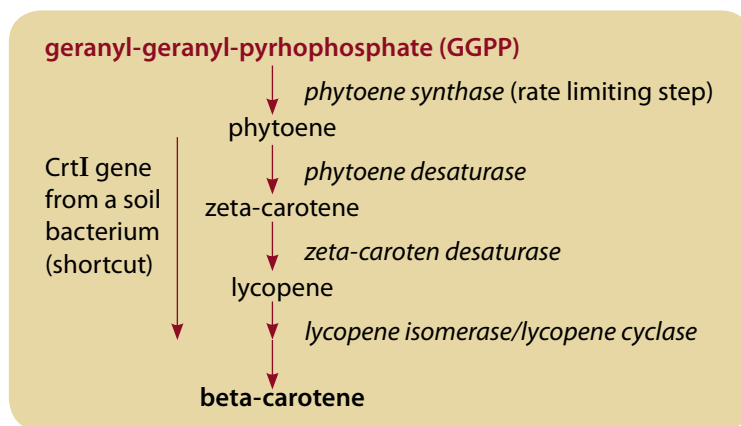

Figure 7. The pathway of Golden Rice, with shortcuts and rate limiting steps.

Imagine arriving in London at Heathrow Terminal wanting to get to Northwood. The London Underground takes you there, and each station represents an enzyme helping the process along. We all know where the difficult situations are. For example at Euston Square you have to change trains; there are a lot of deviations and you can easily lose your way. This is a truly rate limiting step. If you instead of passing there could make it straight to Northwood, it would be much easier.

In gene technology, the shortcuts are there. And we do not need to invent them: we borrow them from organisms that have already invented them for us. Golden Rice is an example of both bottlenecks and shortcuts.

The ordinary pathway for plants synthesizing beta-carotene is well known, but four of the genes involved are missing in rice (figure 7). In Golden Rice, part of this gap was filled with one single gene (CrtI) from the soil bacterium *Erwinia herbicola*, producing one single enzyme replacing a pathway for which plants need three genes producing three enzymes, achieving the same result. That is a significant simplification of the technology.



Figure 8. Exchanging phytoene synthase from daffodil with the same enzyme from maize made the rice deeper yellow, reflecting the more efficient synthesis of beta-carotene.

There is also a rate limiting step: the enzyme phytoene synthase transferred from daffodil into rice proved to be the slowest in the process. But exchanging it against the same enzyme from maize widened this bottleneck and made the production of beta-carotene much more efficient. This makes the difference between Golden Rice 1 giving six micrograms beta-carotene and Golden Rice 2 capable of producing 25 micrograms beta-carotene per gram of rice (figure 8).

### The potential of nutritional genomics

Knowledge on enzyme pathways for micro-nutrients is progressing rapidly.

Folate (vitamin B<sub>9</sub>) is an example of two minor adjustments of the pathway making the whole difference. Folate deficiency may lead to neural tube defects in foetuses, and fortification of flour has become mandatory in the United

States and many other countries. But vitamin B<sub>9</sub> is a complex molecule with complicated pathways: the synthesis takes place in different cell components with interfering transport phenomena between these compartments. Still, two separate research groups<sup>2</sup> have recently clarified that only two genes, reading for two enzymes, are the real bottlenecks. These enzymes just need to be upregulated to make the folate synthesis work a little bit faster. Transplanted from *Arabidopsis*, these two genes have made rice reaching levels of folate high enough to fulfil the recommended daily allowance. This is a major discovery, one of the real breakthroughs in pathway engineering, that of some strange reason has not yet received interest by any donor agency to develop further.

Iron deficiency (anemia) prevails in one third of the world's population, but here bioscience still has some way to go. Iron is not biosynthesized; it has a complicated pattern of uptake from the soil and transport through the tissues with up to 34 genes involved, and the rate limiting steps are not yet clear. Work is ongoing, but so far only single gene transformations have been made, overexpressing the ferritin gene from beans thereby increasing the iron content in seed grain.

Most plant proteins are nutritionally imbalanced because of deficiencies in certain essential amino acids. Cereals have lysine as the first limiting amino acid, while legume seeds and vegetable proteins are poor in the sulphur containing methionine and cysteine.

Technologies for engineering lysine synthesis are developed, through model systems. The pathway is known in all its complexity with rate limiting steps and feedback regulations. Different research groups have managed to increase lysine content in rice with up to 40 percent.

2. *High folate tomato*. By de la Garza *et al.* Published in 2007 in *Proceedings of the National Academy of Sciences*. High folate rice. By Storozhenko *et al.* Published in 2007 in *Nature Biotechnology*.

These are only some examples of how far bio-engineering to fortify food crops has come. However, the real potential of nutritional genomics lies beyond producing nutritional compounds. The next option may be to improve the bioavailability of minerals through changing the biochemical environment.

For instance, it is well known that vitamin C helps in the uptake of iron. Also fructans and the sulphur-containing amino acids are promoters of mineral bioavailability. Molecular pathway information is sufficiently available to improve those promoters, or to downregulate inhibitors of bioavailability such as phytates, tannins and polyphenols.

### **The prospects of success**

Golden Rice and other nutritionally improved food crops are made to benefit the consumer. One driver for success is getting the farmers to grow them, which will depend on combinations with agronomic traits. The first generation of GM crops (with herbicide and insect resistant maize, cotton and soybean) has been successful in many parts of the world, therefore the prospects are promising.

Regulatory compliance costs are often quoted as a hindrance for the development of genetically modified crops. But comparing with the cost of current practice, it is not inhibitive.

The estimated cost of breeding one biofortified line is USD four million per variety over ten years. The regulatory compliance costs can increase this figure four to eight times. This is still only a fraction of the (well-spent) funds for ten years of supplementation.

Around 500 million vitamin A capsules are being distributed every year, to an estimated cost of USD one per person per year, sums up to USD five billion over ten years. The cost of breeding is only one percent of this amount.

In fact, new technologies have a tendency to be overregulated. A classic example is the Locomotive Act in the United Kingdom, in force from 1861 to 1896, for public safety requiring every self-propelled vehicle (i.e. car) on public highways to be preceded by a man on foot waving with a red flag and blowing a horn. Therefore, with confidence it can be envisioned that with time the regulatory requirements will be reduced.

**“Let food be your medicine and medicine your food.”**  
*Hippocrates 460 BC*



# Biotechnology in agricultural programmes in developing countries

DR. GERARD BARRY

Agricultural biotechnology is increasingly being used around the globe. Farmers, national leaders and industry see the benefit of the technology. They are certainly not waiting for Europe. Many developing countries are ahead and commercial products are already there.

As many crops of importance for the developing countries don't have commercial interest for the multinational companies to be engaged in, government support and public research sector programmes are two important driving factors.

## GM crops around the world

In spite of regulatory complications and negative publicity, the production of GM crops is steadily increasing. According to the International Service for the Acquisition of Agri-biotech Applications (ISAAA), in 2007, there were 23 countries growing 114 million hectares GM crops commercially, mainly with insect resistant cotton, maize and soybean. This is an increase of twelve percent from the year before. Most is grown in some larger countries such as China, India, Brazil, Argentina, the United States, Canada and South Africa, but also eight European countries had some minor acreages of Bt maize (figure 9).

Recombinant DNA modification is a scale neutral technology. Of the twelve million farmers who grew GM crops in 2007, eleven millions were small-scale farmers in developing countries.

Farmers growing GM crops get higher yields and revenues, lower pesticide costs, and

(naturally) increased seed costs. A study on performance advantage of insect resistant (Bt) over conventional cotton showed that the average profit was 12 to 300 percent higher for farmers growing Bt cotton (table 4). It has also been shown that small-scale farmers make more money out of GM crops than large-scale farmers.

The preference of traits among publicly financed research projects gives an indication of which traits and crops that are of highest interest. Of 109 advanced projects in 2004 (i.e. carrying out greenhouse tests), one third were working on insect resistance while a quarter dealt with virus resistance, on as much as 30 different crops (figure 10).

In nearly all cases this insect resistance means resistance to the Lepidopteran pests (moths and butterflies) through transferring the Bt gene into the crop. Due to lack of genetic variation on Lepidoptera resistance in plants, it is not possible to breed for. Therefore,

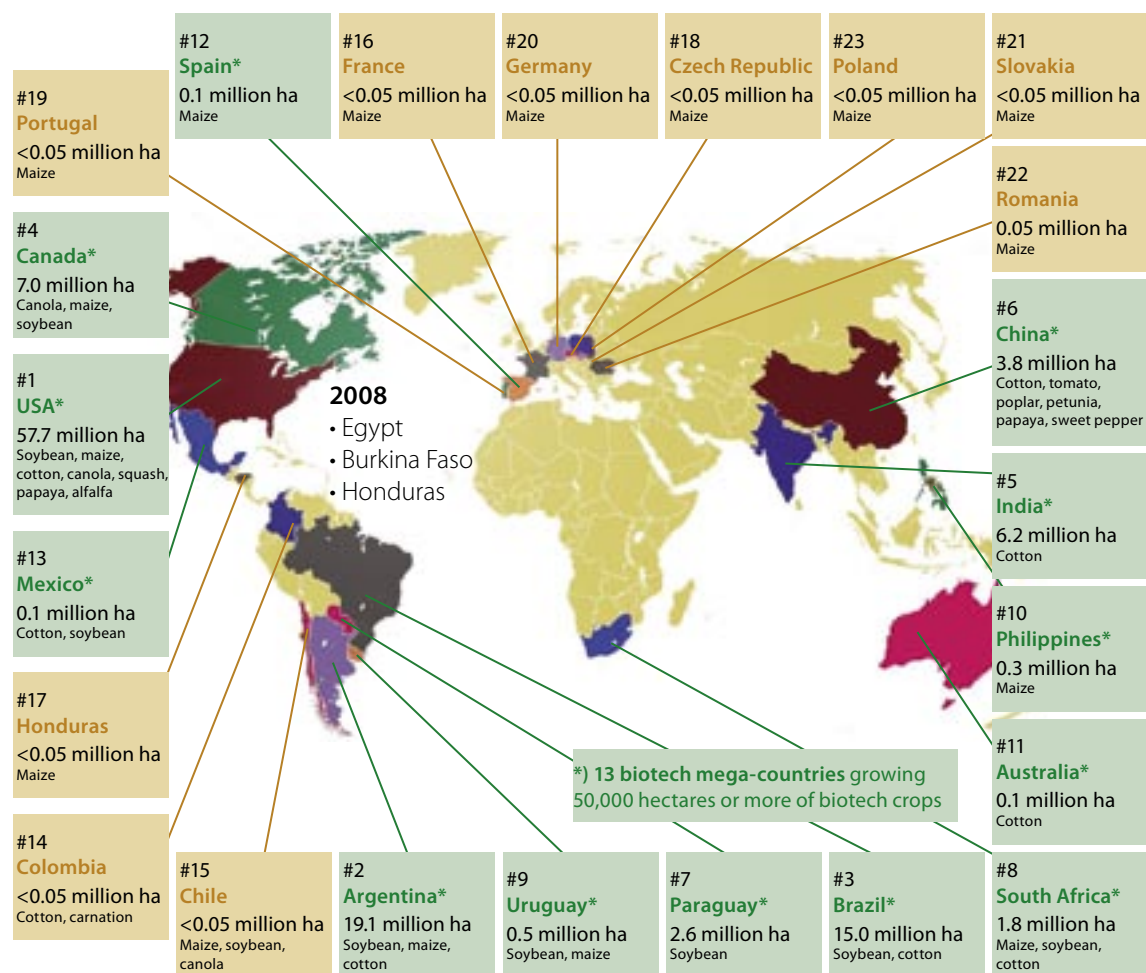

Figure 9. Countries growing biotech crops commercially in 2007, and their acreage (after Clive James, 2007).

Table 4. Performance advantage of insect resistant over conventional cotton (expressed as percentage), based on peer-reviewed studies of two to three seasons of commercial farm production (adapted from Raney, T. [2006] Economic impact of transgenic crops in developing countries. Current Opinion in Bio-technology 17:1-5).

	Argentina	China	India	Mexico	South Africa
Yield	33	19	34	11	65
Revenue	34	23	33	9	65
Pesticide costs	- 47	- 67	- 41	- 77	- 58
Seed costs	530	95	17	165	89
Profit	31	340	69	12	299

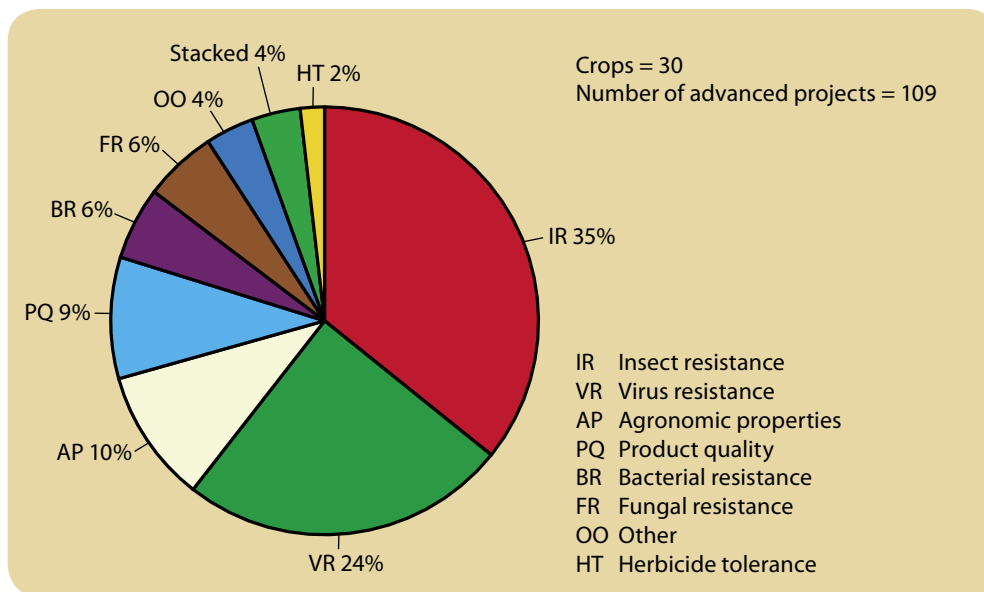

Figure 10. Regional distribution of phenotypic traits in public sector projects in Asia (adapted from To reach the poor, by Atanssov et al. 2004, with results from the Next Harvest Study, International Service for National Agricultural Research [ISNAR]–International Food Policy Research Institute [IFPRI]).

the Lepidopteran pests cause enormous losses in many types of crops, or result in massive use of pesticides.

### Daunting regulations don't stop India

Getting a new variety through the regulatory requirements for genetically modified crops in India is a daunting task, but similar to the situation in many other countries. Fortunately, the process is not prohibitive and both the private and public sectors are supportive, taking initiatives on a large variety of crops and traits.

To begin with, the Institutional Biosafety Committee gives approval to the laboratory research. Thereafter, the Review Committee of Genetic Manipulation (RCGM) under the Department of Biotechnology authorizes the contained field trials and oversees the biosafe-

ty and multi-location testing. Eventually the Genetic Engineering Approval Committee (GEAC) under the Ministry of Environment and Forest (MoEF) approves on large scale trials and authorizes the commercialization (the manufacture, use, import, export and storage) of the genetically modified organisms.

The first product that went through this regulatory process was one Bt cotton event, in 2002, at a time when the same crop had already been approved for cultivation in five other countries.

In 2005, India carried out field trials on eggplant (brinjal), cabbage, cauliflower, maize, cotton, okra, pigeon pea and rice, all with the Bt gene, and on groundnut, mustard and tomatoes with other traits. For every year, new gene events are being approved for testing. All these crops are of major importance in various parts

of India, but several of them, such as groundnut, okra and pigeon pea, are of little current commercial value for multinational companies. Any initiative has to come out of national interests, either through the private or the public sector. And that is actually happening.

For example, the Government of India has provided a set of Bt genes with legal freedom-to-operate to a number of public institutions in India, which means they are not obligated under any patent regimes. Separately, the Indian private enterprise Maharashtra Hybrid Seeds Company Limited (MAHYCO) was in 2006 planting nine trials of Bt rice in seven states of India. Some work that would never be done by any multinational is the biofortification of pigeon pea with beta-carotene, methionine and lysine, and of groundnut with beta-carotene, carried out under the auspice of the International Crops Research Institute for the Semi-Arid Tropics (ICRISAT).

### Strategic industry in China

When China eventually will put its mind to the gene technology, it is going to be in a big way. There has been good progress, but also some unexpected drawbacks.

To date, China has approved seven GM crops for commercial production. They have two types of cotton—one from Monsanto and one developed by the Chinese Academy of Sciences; a colour-altered petunia; virus resistant and shelf-life altered tomato; virus resistant sweet pepper and papaya; and insect resistant Bt poplar trees forming the world's largest transgenic forest.

When approved, Bt rice is expected to be the highest profile product in China with an estimated annual impact value of USD four billion. The crop has been under development since the mid-nineties, but while awaiting the

*"To solve the food problem, we have to rely on big science and technology measures, rely on biotechnology, rely on GM."*

– Wen Jiabao, Premier of China's State Council, 2008

commercial approval a new biosafety committee was constituted and new tests required. Current indications are that at least one Bt rice variety will be commercialized in 2009, but at this time it is largely a political decision.

Recent events indicate that the breakthrough might be near. According to *Science Magazine*<sup>1</sup>, China has declared agriculture biotechnology a strategic industry and announced plans for major investments in research on GM crops. China is planning for a transgenic green revolution to secure its food supply and also wishes to catch up with the West in the race to identify and patent plant genes of great value.

### GM crops in Africa

Until now, only South Africa has been growing GM crops commercially. But that is changing as also resource poor countries in Africa are turning towards gene technology.

The cotton industry in Burkina Faso had recognized the advantage of other countries growing Bt cotton and struck an alliance with Delta & Pineland and Monsanto. They got the regulations for field testing in place and started trials in 2003. And in 2008 they have come to the stage of commercialization—all driven by the need of those benefiting: farmers and the cotton industry. Also Egypt is commercializing its first Bt crop in 2008.

Cowpea (black eye pea) is widely grown in Africa. The crop is drought tolerant and does well on poor soils, and as also leaves and pods are eaten it bridges the "hunger gap" before

1. China plans \$3.5 billion GM crops initiative. Article in *Science Magazine* 5, September 2008, page 1279.



crop maturity. But the cowpea is susceptible to the Maruca Pod Borer, and the only remedy is spraying for those who can afford it. With funding from the United States Agency for International Development (USAID) and access to property rights and technical advice provided by Monsanto, the same Bt gene used against the related European Corn Borer is transferred into cowpea. Advanced lines of Bt cowpea will shortly be tested in field trials, to start with in Puerto Rico and then subsequently in West Africa. The driving forces behind the work are the African Agricultural Technology Foundation (AATF) and the Network for Improvement of Cowpea for Africa (NGICA). Again, this is an example of a GM crop that would never have been developed by anybody who doesn't realize how critical cowpea is for the population.

East African highland banana (plantain) is an important food crop mainly grown by small-scale farmers. The crop suffers several pest and disease constraints, but conventional breeding is not possible. In collaboration between the National Agricultural Research Organization (NARO) in Uganda and Queensland University of Technology in Australia, work has begun on transgenic biofortified banana. Separately, other efforts are underway to develop a transgenic banana resistant to nematodes and Black Sigatoka.

### Asian collaboration

One success story is the work on the Fruit and Shoot Borer resistant eggplant (Bt eggplant). Eggplant is an important vegetable in India, Bangladesh and the Philippines, primarily grown on small family farms, for own consumption or as local cash-crop. The Fruit and Shoot Borer commonly leads to major losses unless heavy pesticide regimes are used. In a

large consortium and with USAID support, the commercial product will be made available to small-scale farmers in several countries through public-private partnerships.

MAHYCO in India has developed a Bt eggplant resistant to the pest. Private and public independent institutions in India, Bangladesh and the Philippines are developing test data; large-scale trials are ongoing and all the regulatory data is publicly available on the website<sup>2</sup>. The original Indian event has been backcrossed into different local eggplant varieties.

Potato is grown in many countries; in Bangladesh it is the second most important food crop. The fungal disease Late Blight<sup>3</sup> often leads to complete losses, and is also recently becoming resistant to the traditional fungicide. With a gene from wild potato, a research group in Wisconsin managed to develop a variety that in field tests in India and Indonesia has shown quite dramatic protection against the disease.

Papaya is the largest fruit crop in the Philippines, and high value in many countries. It is vulnerable to Ringspot Virus and losses can be up to 80 percent. China and the United States have already released virus-resistant Papaya. The Philippines is in an advanced stage, as is Vietnam, Malaysia and Indonesia. Field testing is being carried out in the Philippines on virus resistance and also on late ripening.

With climate change, the dry areas will get dryer and the wet areas wetter, and more violently so. The Rockefeller Foundation has funded a large project in Wuhan comparing all public sector single gene drought tolerance approaches in rice, which will inform how to handle the increased drought stresses.

### Sudden changes in Brazil

After individual farmers illegally importing seed from Argentina, Brazil is now officially

2. [www.enrfor.nic.in/divisions/csurv/geac/information\\_brinjal.htm](http://www.enrfor.nic.in/divisions/csurv/geac/information_brinjal.htm)

3. Late Blight was the cause of the Irish famine in the mid-eighteenth century

turning toward the gene technology in a big way. Trials are ongoing on maize, cotton, rice and soybean, but also on sugarcane, eucalyptus, potato and beans.

The first GM soybean (herbicide tolerant) was approved in 2003 and today 65 percent of all soybean in Brazil is transgenic. Three years after the release in 2005, already 50 percent of the cotton is Bt (i.e. insect resistant). Recently, Brazil has commercialized three GM maize varieties, one with herbicide resistance and two different with insect resistance. In 2008, the first year of release, it made up four percent of all maize, and depending on seed supply is estimated to cover between 40 and 90 percent after one to two years.

Sugarcane is grown on seven million hectares, half for sugar and half for ethanol. Brazil has a serious commitment to expand the ethan-

ol industry with a target to double the production by 2020. Staying on the same productivity would mean using twice as much land. Therefore, in 63 field trials in 2008, Brazil is testing transgenic events producing 40 percent more sugar, and having better productivity by being insect resistant and herbicide tolerant. Sometime shortly we will see GM sugarcane in the field.

### **Public initiatives a key**

For crops of local importance, government support and public research sector programmes are important driving factors. The Public Research Regulation Initiative (PRRI)<sup>4</sup> is a consortium of public sector researchers informing each other, policy makers and journalists on modern biotechnology developments around the world.

---

4. [www.pubresreg.org](http://www.pubresreg.org)

# Reaching the rural poor with biofortified crops

PROF. J. V. MEENAKSHI

Biofortified food crops hold a potential for improving nutrition in developing countries in a cost-effective manner, because it is a one time investment that can generate returns year after year. These foods reach further into the rural areas where consumption of mill-processed fortified foods is low; to where malnutrition is highest.

This presentation discusses how to reach the rural poor with the biofortified foods—using

both conventional and transgenic approaches. Whether the biofortification is done through conventional breeding or transgenics is not important—they are just two different techniques.

Combining biofortification with for farmers desirable traits; getting the consumers to accept the food and including the concept into country programmes are crucial components for sustainability of the efforts.

## Biofortification and other interventions

A range of different biofortified crops is being developed, where Golden Rice is only one (table 5). Most of these are developed through conventional breeding and not transgenics. Whichever of these techniques is being used isn't the issue for getting a remedy able to counteract the micro-nutrient deficiencies for millions of people.

There are of course other possible interventions. *Supplementation* with capsules or injections are widely used with increasing coverage rates, but recurrent costs are high—for vitamin A capsules for example, USD 500 million per year is necessary<sup>1</sup>.

*Fortification* of commercial foods has a natural niche in urban areas. But in rural areas, much of the grain is processed daily in small-scale mills. Adding the fortification is technically possible, but monitoring the appropriate

addition of the fortificants at such small scale entails considerable costs (figure 11).

Table 5. Schedule for product release of various biofortified food crops (as projected by HarvestPlus).

Crop	Nutrients	Release year of initial lines
Sweet potato	Pro-vitamin A	2007
Bean	Iron, zinc	2011
Pearl millet	Iron, zinc	2011
Rice	Zinc, iron, pro-vitamin A	2012
Maize	Pro-vitamin A	2013
Wheat	Iron, zinc	2013
Cassava	Pro-vitamin A	2014

1. Estimating the global costs of vitamin A capsule supplementation: a review of the literature. By O. Neidecker-Gonzales *et al.* Published in 2007 in *Food and Nutrition Bulletin*: Vol. 28 (3):307–16.



Figure 11. While fortification in small mills is technically feasible, monitoring costs will be high.

*Kitchen gardens* to promote dietary diversification is yet another intervention, but little is known about their cost-effectiveness.

The highest incidences of micronutrient deficiencies are at present seen in the rural areas, because they don't have access to mill-processed foods on a regular basis. It is here that biofortification has its niche. Biofortification complements other interventions, by targeting rural areas where the others don't reach out effectively. It is also more cost-effective; and, if successful, a one-time investment with minimal recurring cost.

### Reaching the people

How can we ensure a widespread adoption of the biofortified crops? There are two sides to the coin. If

farmers don't grow the biofortified crop, there isn't going to be anything to consume. But producing is not enough; it also has to get into the diets of the women and children needing it.

The scenario is fairly complex. HarvestPlus<sup>2</sup> has developed a framework for analysing the potential for widespread adoption, built on the assumptions that invisible traits will be easier to promote than visible, and that infrastructure will have strong influence on the cost of dissemination (figure 12).

The only visible trait in biofortified foods seems to be beta-carotene, while minerals don't change the appearance or organoleptic characteristics.

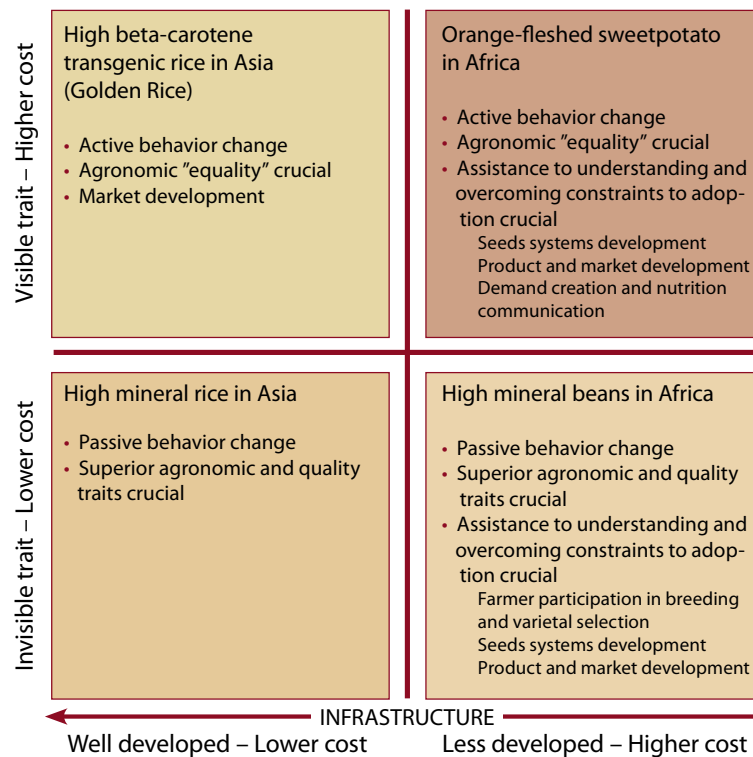

Figure 12. Framework for analysing potential reach of biofortified crops.

2. HarvestPlus is a global challenge programme of the Consultative Group on International Agricultural Research (CGIAR), and is coordinated by the International Center for Tropical Agriculture (CIAT) and the International Food Policy Research Institute (IFPRI).

While the problem is quite acute for both continents, in areas with well-developed infrastructure like in many parts of South Asia, people are accustomed to trying new varieties, whereas in relatively less developed infrastructure like in Africa, it may cost more to reach out with the biofortified varieties.

### High-zinc rice in Bangladesh

When trying to disseminate the high-zinc rice in Bangladesh, there are several advantages. With an invisible trait, there may have to be some, but only passive, behavioural change among consumers. The combination of good infrastructure and dominance of a few mega-varieties will also be helpful to widespread adoption and acceptance of biofortified rice.

In Bangladesh, there is a well-established public extension system. As much as 70 percent of large and 50 percent of marginal farmers get their first information about new varieties from the extension agents. By plugging in to this system already in place, the dissemination of biofortified varieties will be facilitated, especially as the biofortified trait piggy-backs on an agronomic feature.

It is necessary to understand the varietal diversity in a country. With the high-zinc rice transferred into two main varieties, BR11 for the *Aman* season and BR29 for the *Boro* (dry) season, a large area of the rice grown in Bangladesh will be covered.

### Orange sweet potato in Uganda

The selling in of beta-carotene fortified sweet potato in Uganda is a very different story. The trait is visible, requiring active behavioural change, the infrastructure is less developed and there are no mega-varieties like in Bangladesh. The adoption is not going to be widespread without certain interventions.

In Uganda, farmers are not relying on the public extension agents to any higher degree. Therefore, women, farmers and local non-governmental organizations must be involved.

Efficacy studies show that eating even small amounts, about 100 grams per day, of sweet potato will give children their daily requirement of vitamin A. But the new variety looks very different from the normal white or cream coloured potato. How can we make sure that people are going to eat this? The health benefits don't appear overnight. And if promotion doesn't come right, the colour may even be an obstacle. In parts of sub-Saharan Africa there have been examples of resistance to yellow coloured maize distributed as food aid.

The agronomic quality is very important. In Africa, it is harder to get widespread adoption of new varieties, as it requires the development of seed systems in a way not needed in South Asia. The product and market development needs a level of intensity much higher than in South Asia. There must also be focus on nutrition communication, creating demand for this visible trait.

### Golden Rice

About Golden Rice, the farmer acceptance is probably not going to be such an issue, as long as the agronomic traits are right and especially if the rice is associated with a price premium. Crossing into mega-varieties (such as BRRI Dhan 28 and 29) which cover a third to half of the total area is sensible.

But the consumer acceptance needs to be well researched. Are they likely to eat orange rice that is also transgenic? The important issue is which levers can be manipulated to ensure consumer acceptance and not make it an obstacle. Studies are initiated but remain largely in the hypothetical realm.

## Ensuring sustainability

Biofortification is a relatively blunt instrument, in that it needs to be mainstreamed into all varieties of primary staples—be they conventionally bred or transgenic.

The worst thing that can happen is releasing a new drought-resistance maize variety that doesn't have the biofortified trait. The drought-resistant maize would spread like wildfire, and nobody would request for the biofortified trait.

Country ownership will be crucial for impact. For HarvestPlus, the vision is to engage with country programmes early to achieve an enabling environment with combined efforts from all three sectors agriculture, food processing and health, both in research and in the dissemination of crops and messages. As shown in table 6, a holistic engagement across the whole spectrum of players from policy level to the consumer on various aspects related to biofortification will be needed.

*Table 6. Combined efforts between different ministries and sectors, and a holistic approach with enablers, diffusers and users will be necessary for ensuring sustainability.*

<b>Component</b>	<b>Actor</b>	<b>Enabler</b>	<b>Diffuser</b>	<b>User</b>
Extension/ seed system		Ministry of agriculture, Seed board	NGOs Extension programmes Private sector	Farmers
Marketing/ product development		Ministry of food processing	Food processors Food companies	Millers Traders
Demand creation		Ministry of health, WHO, media	Health clinics	Consumers

## ORANGE SWEET POTATO IN AFRICA

HarvestPlus is trying to find out the most cost-effective way of introducing beta-carotene fortified orange sweet potato in Uganda and Mozambique. The work covers the whole chain, from farmers adopting the new variety to consumers accepting to eat the food, including product promotion and marketing, and a whole nutritional education package where sweet potato is only a component. The diagnostic work ended in mid 2008 and the two year pilot project will be through in 2010.

### Two models are tested:

1. An intensive high-cost version with frequent contacts with farmers and consumers. This should give high coverage and indications of useful methods, but will be too costly to use on a regular basis.

2. A more modest version, which will give less coverage but with lower cost per beneficiary household. This will probably be the model for replication.

Four types of sweet potato with different colours are tried with taste tests and willingness to pay. Preliminary results show that even without information, the consumers have no problem buying as long as the price is about the same on all varieties. However, if the food was provided together with nutrition information it translated into a premium, for the orange varieties of up to 40 percent.







# Impact assessment of Golden Rice in India

PROF. MATIN QAIM

Sound impact assessments can rationalize the debates around Golden Rice, and also support the regulatory process.

By using the method of *disability-adjusted life year* (DALY) and India as an example, this presentation shows that the problem of vitamin A deficiency (VAD) is indeed large, and that Golden Rice can reduce it in a cost-effective way. Yet, the

ultimate success of Golden Rice will depend on public support to technology development, release and distribution.

Since all micronutrient interventions have their strengths and weaknesses in particular settings, Golden Rice should be seen as a complement rather than a substitute for the others.

## The public debate

There is an emotional public debate going on around Golden Rice, genetically engineered to produce beta-carotene. The argument of the supporters is rather straight forward:

- Golden Rice can enhance the vitamin A status in rice-eating populations and thus reduce the malnutrition and health problems related to vitamin A deficiency.

The opponents are generally equivalent with the anti-biotech lobby. Their arguments are:

- General health and environmental concerns against genetically modified crops.
- A technical fix like Golden Rice would be inappropriate to deal with vitamin A deficiency as this is a multi-faceted problem.
- There are many natural food sources of beta-carotene and other alternative interventions such as supplementation, fortification, home vegetable gardens and diet diversification.
- The private sector and in particular the multinationals dominate the development of GM

crops and hold many of the patents; therefore seed could become very expensive, creating new dependencies for small-scale farmers.

Many of these opposing arguments are untrue or not fully true, but this is what lay people, policy makers and regulators are confronted with. Against this background, sound and independent impact assessments that can demonstrate costs versus benefits can be an important ingredient in the debate.

## Quantifying health gains

With India as an example, research at the Universities of Hohenheim and Göttingen has developed a framework to evaluate and quantify the potential health benefits of introducing Golden Rice into vitamin A deficient societies.

For crops with improved agronomic traits, the benefits are easily evaluated in terms of pro-

ductivity and income effects. Crops biofortified with micronutrients, however, will not cause direct productivity and income gains but reduce certain health problems. Thus, the benefit of Golden Rice is the reduction of the problems associated with micronutrient deficiencies, or vitamin A deficiency in particular. These problems are in short:

- Child mortality; in high risk countries child mortality could be reduced by up to ten percent if all children were better nourished with vitamin A.
- Susceptibility to infectious diseases.
- Eye problems, such as night blindness, corneal scarring and permanent blindness.

With that background, the benefit of Golden Rice can be calculated as the health burden of a society after its introduction compared to the situation before it was introduced.

For quantifying the health burden, the *disability-adjusted life year (DALY)* approach was chosen<sup>1</sup>. One DALY is equivalent to one year of healthy life, and the DALYs lost comprise the number of years lost due to premature mortality plus the number of years of disability, multiplied with a factor reflecting the severity of each disability (between 0 for completely healthy and 1 for dead), in the following equation:

$$\text{DALYs lost} = \text{years lost due to mortality} + (\text{years with disability} \times \text{disability weight})$$

In the context of vitamin A deficiency, the disability problems are infectious diseases and eye problems. The mortality is to a large extent children dying, and as they had many years left to live, high child mortality makes the largest contribution to DALYs lost.

The benefit of Golden Rice would then be equivalent to the DALYs lost due to VAD before Golden Rice was introduced minus the DALYs lost after introducing Golden Rice:

$$\text{DALYs saved through Golden Rice} = \text{DALYs lost without Golden Rice} - \text{DALYs lost with Golden Rice}$$

## Empirical study for India

India is a major rice eating country and VAD is a large health problem. Of the 140 million children worldwide that suffer from vitamin A deficiency, more than 35 million live in India. Over 70,000 children die every year in India due to vitamin A deficiency and more than four million suffer from night blindness.

Using the equation above, 2.3 million DALYs are lost in India every year due to vitamin A deficiency (table 7). Blindness accounts for only a small fraction of these DALYs lost, the reason being that child mortality is the most important functional outcome, contributing to about 90 percent of the DALYs lost.

Table 7. Annual health burden of VAD without Golden Rice, in India.

Functional outcome	Cases attributable to VAD	DALYs lost
Child mortality	71,625	2.04 million
Night blindness	4.2 million	0.19 million
Blindness	3,663	0.07 million
Measles	0.8 million	0.02 million
<b>Total</b>		<b>2.32 million</b>

Vitamin A intake in populations follows a normal distribution and is usually related to income, where the lower income spectrum has the lower vitamin A intake. Once people start consuming Golden Rice, that intake distribution will shift, leading to a lower fraction of people below the vitamin A requirement level (figure 13).

1. Disability-adjusted life year (DALY) is a time-based non-monetary index quantifying the annual health burden of a particular disease. It was developed by WHO and is increasingly used for health impact assessments.

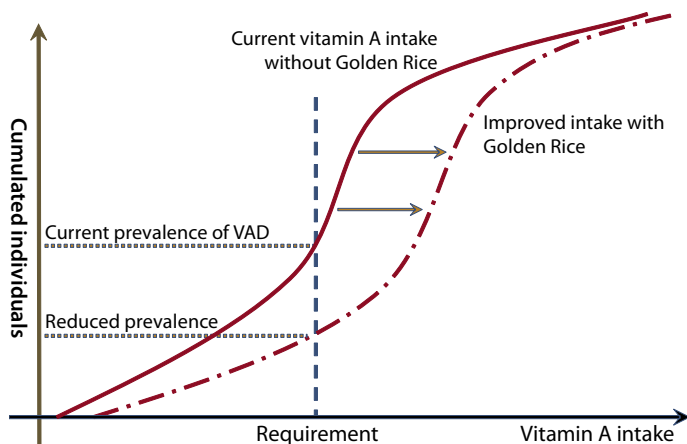

Figure 13. Improvement in vitamin A intake with Golden Rice.

The impact of Golden Rice will depend on three main factors:

- *Rice consumption:* In India, there is regional heterogeneity in rice consumption, with some regions depending entirely on rice while others, for example northern India, eating more wheat.
- *Efficacy:* Several variables influence the efficacy, such as the amount of beta-carotene in the grain; post-harvest stability of the beta-carotene and its bio-availability in the body.
- *Coverage:* How much of the total rice consumption that will be replaced by Golden Rice depends on consumer acceptance and farmer adoption which in its turn depends on a number of variables.

To establish the current vitamin A intake distribution of rice in India, data from 120,000 households, representative of all states in India, was used.

The variables efficacy and coverage are not known at this stage. Expert interviews were conducted based on which assumptions were made. Building on these assumptions, two scenarios were used for the calculations, one optimistic, high impact scenario, and one more modest, low impact scenario (table 8). The actual outcome will probably lie somewhere in between.

Calculating with the high impact scenario, the benefits of Golden Rice were found to be a reduction of the DALYs burden by close to 60

Table 8. A high and a low impact scenario were used in the impact assessment for India.

	High impact	Low impact
Beta-carotene content in Golden Rice	31 ppm	14 ppm
Post-harvest losses	35%	80%
Bioconversion into vitamin A	3:1	6:1
Year for technology release	2011	2013
Coverage after 15 years	50%	15%

Table 9. Benefits of Golden Rice in India.

	High impact	Low impact
DALYs lost without GR	2.32 m	2.32 m
DALYs lost with GR	0.95 m	2.12 m
DALYs saved through GR	1.37 m	0.20 m
Reduction in health burden	- 59%	- 9%
Child deaths averted per year	39,700	5,500

percent, including nearly 40,000 child deaths averted per year in India alone. The low impact scenario resulted in nearly 10 percent reduced health burden, and 5,500 child deaths avoided per year (table 9).

### Increasing the impact

Both the optimistic and the modest scenarios give remarkable results. But the most desired outcome is of course that the high impact result is nearest the truth. Therefore, the assumptions were reviewed again to find the options for increasing the benefits of Golden Rice.

Increasing the efficacy is basically a function of selecting the right transformation events based on proper testing and feeding trials, that is getting the technology development right.

Increasing the coverage is a function of social marketing, getting the consumers to accept the golden coloured rice. But it is also a question of how many Golden Rice varieties there will be available for the farmers. As India is a large country with different agro-ecological conditions, to increase the coverage, the germplasm (beta-carotene trait) has to be transferred into the absolutely best varieties that the farmers will want to use in their particular locations. These variables can be influenced primarily by supportive policies and national breeding systems.

Therefore, whether we get the high or low impact scenario is not just by chance. It is an issue of public support, where for example an efficient regulatory framework can be very helpful.

Sensitivity analyses on low impact plus high coverage, and vice versa, showed that both variables are important, but the highest impact was given by high efficacy (figure 14). This gives an important message to the R&D institutions to do proper line selection and testing.

### Cost-effectiveness

The cost-effectiveness analyses show that the high impact scenario costs USD 28 million while the low impact scenario costs around USD 21 million for the whole of India (table 10).

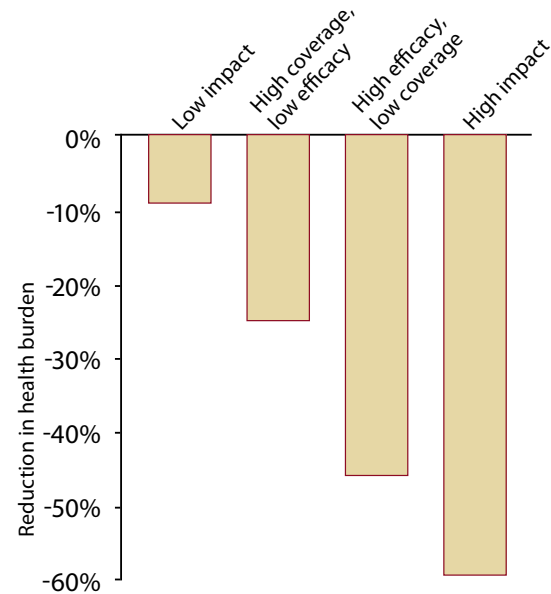

Figure 14. Sensitivity analysis.

The largest fractions go to regulation and social marketing.

The cost per DALY saved is in the high impact scenario USD 3 and in the low impact scenario USD 19 per DALY (table 11). Comparing with other interventions to reduce VAD, vitamin A supplementation costs USD 134 per DALY saved and industrial fortification of wheat flour or margarine costs on average USD 84 for saving one DALY. The World Bank classifies health interventions as cost-effective when the costs are below 200 USD per DALY saved.

The reason for Golden Rice being so cost-effective is that it is a one time investment. Developing Golden Rice and getting it out to the farmers is expensive, but once that is done the farmers will reproduce their own seeds and spread them further by formal and informal channels. Therefore, there will hardly be any recurrent costs. The calculations are based on a 20 year benefit stream with gradually increasing adoption and coverage rates. Costs for maintenance research were taken into account.

Table 10. Net present value of cost (million USD).

	High impact	Low impact
R&D, regulatory process, and marketing/distribution	27.9	21.4

Table 11. Cost-effectiveness (USD per DALY saved) of Golden Rice and other interventions.

	High impact	Low impact
Golden Rice	3.06	19.40
Vitamin A supplementation	134	
Vitamin A industrial fortification	84	

Supplementation and fortification, on the other hand, have to be paid for year after year and especially in remote areas the cost of distribution is very high.

## Alternatives to Golden Rice

There are several other alternatives for decreasing the VAD problems mentioned in the debates.

Some landraces of rice contain beta-carotene in the husk. But even if people would turn to eating unmilled rice, the maximum amount of beta-carotene found is in the magnitude of 0.4 ppm which would reduce the health burden by only three percent.

Increasing dietary diversity, especially with animal source foods, would make any vitamin A intervention unnecessary, but due to the income constraints among the poor and, in India in particular, cultural restrictions about eating meat or eggs, this is not a realistic option in the short to medium run.

Red palm oil contains high amounts of beta-carotene. But covering all children in India would require a large expansion of the oil palm area, competing for food production and biodiversity. Promoting the use of red palm oil as a nutritional supplement for children has been tried for decades, so far without any significant success.

Establishing home vegetable gardens is often assumed to be a zero-cost intervention but actually requires technical assistance, regular input supplies and availability of family labour time.

All these alternative interventions have their strengths and weaknesses in particular settings

and can play a role, but none is going to solve the problem of VAD alone. Therefore Golden Rice should not be considered as a substitute but a complement to these other interventions. The additional and cost-effective intervention of Golden Rice is highly welcome.

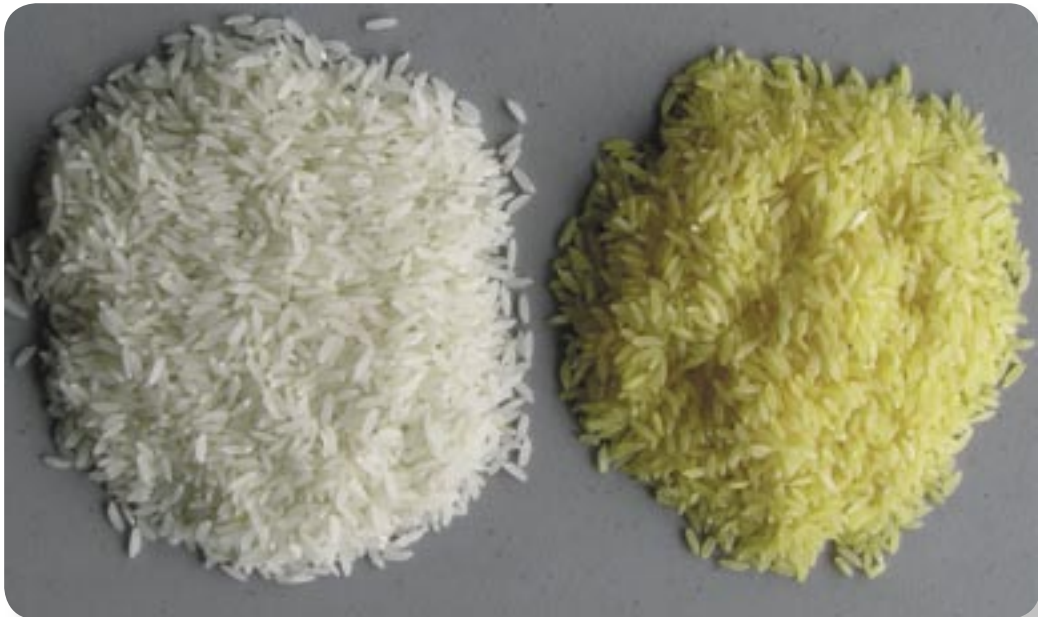

---

Read more

Genetic engineering for the poor: Golden Rice and public health in India. By Alexander J. Stein, H.P.S. Sachdev and Matin Qaim. Published in 2008 in *World Development*, vol. 36, issue 1, 144–158.

# Discriminatory regulations prevent progress

Explaining resistance to agricultural biotechnology, p 57

When is food safe enough?, p 63

Achieving risk-based regulation: science shows the way, p 69

Golden Rice and progress towards GMO-deregulation, p 75





# Explaining resistance to agricultural biotechnology

PROF. ROBERT PAARLBERG

Even though gene modified crops have been around for twelve or so years, they are not used in most parts of Africa. The reason is that the African governments have set in place strict European style regulations for GMOs. These systems have made it nearly impossible for public sector scientists to develop applications of the gene technology as appropriate to the needs of the African farmers. And in nearly all cases they have made it illegal to bring these products to the market.

Why have European societies set up such strict regulations? And why are those strict regu-

lations being transplanted to Africa, which would benefit most from agricultural GMOs?

The answer, this paper argues, lies in that the post-agricultural wealthy populations in developed countries don't benefit directly from these products, and therefore have decided that they can afford not to like them. Due to different political systems and different models for regulation of gene modified organisms, Europe has a near ban on them, while the United States has taken a more permissive attitude. And Africa tends to adopt the European approach.

## Opposing models of regulation

There is a large contrast between the strict European and the permissive American style of regulations on gene modified organisms (table 12).

The European approach has required the enactment of new separate laws regulating GMOs. In the United States there are no separate laws—the existing ones regulating conventional crops for food safety or biosafety have simply been extended to cover also GMOs.

Europe has created new and separate institutions and processes, while the United States relies on existing institutions and processes for the approval of GMOs.

Under the precautionary principle, the European regulators employ more than just the

standard tests for known risks. Approvals may be delayed without any evidence of known risks such as toxicity, allergenicity or unwanted gene flow, only because of some lingering uncertainty or hypothetical hazard that hasn't yet been tested for. Such interpretation of the precautionary principle may lead to endless delays, possibly stifling new technologies indefinitely.

## Similar attitudes—political differences

Surveys of consumer attitudes show that many citizens in Europe are cautious about gene modified foods and crops. Surveys in the United States show similar anxiety and that people recently have become more sceptical towards GMOs.

Table 12. *Opposing models for regulation for GMO foods and crops.*

European model	American model
New and separate laws	Rely mostly on existing laws
New and separate approval institutions and processes	Rely mostly on existing approval institutions and processes
A "precautionary" regulatory standard that allows disapproval based on uncertainty	Allow approval if technology passes standard tests for known risks

Only 45 percent of the Americans believe that GM food is safe; 54 percent think that the technology threatens the natural order; half of them say that they would oppose introducing GMOs into the food supply; and only 25 percent of the Americans believe they have ever eaten GM food. These responses actually betray an enormous amount of ignorance, as GMO has been prevalent in the United States for a dozen years now, and that, in fact, closer to 100 percent of the population have eaten GM food. Perhaps one reason for this ignorance is that there is no mandatory labelling required for GMOs in the United States.

The reason for more stringent regulations in Europe is therefore not because European citizens are more fearful or cautious about this technology than the Americans.

The regulatory systems in Europe are stricter for reasons that are largely unrelated to actual risks or perceived risks. Instead, it is part of a larger legal, political and cultural difference between the US and Europe.

Europe takes a stricter regulatory approach, because in Europe it is more likely that regulations will be used before the fact to protect public safety. In contrast, the United States would use class-action laws suits litigation after the fact, to accomplish the same objective.

In Europe with its multiparty political system, commonly green parties find their way into

the governments in a position to legislate their agenda against GMOs into laws, while in the United States with the two-party system, the green parties that emerge are seldom in power to do that.

### **Safety records of a dozen years**

So which regulatory approach is doing a better job?

Logically, the best regulatory system must be the one that allows new technologies onto the market without introducing any new public risks. And evidence suggests that this is exactly what the United States regulatory system is doing!

The vast majority of the agricultural GMOs approved over the last twelve years have been approved by the United States, using a non-precautionary, permissive risk assessment approach. And so far, all national and international academies of science, and a number of international organizations, are in official agreement that there is no evidence of any new risks to human health or the environment from any of the GMOs that have been approved.

This is essentially an official global consensus among science academies that the regulatory systems operating today have been perfectly adequate.

*“No new risks to human health or the environment from GMOs approved by regulators so far.”*

– The Research Directorate General of The European Union (2001), The French Academy of Sciences (2002), The Royal Society (UK) (2003), The British Medical Association (2004), The Union of German Academies of Science and Humanities (2004), The Organization for Economic Cooperation and Development (2000), The World Health Organization (2002), The International Council for Science (2003), The Food and Agriculture Organization (2004) –

Environmental activists may give a different story, but they usually never refer to this consensus. The critics often argue that *absence of evidence* is not the same thing as *evidence of absence*. But looking hard for something for twelve years and not finding it has to be evidence of something. It is not a proof of absence (as proof of the negative is logically impossible) but it can with good accuracy be called evidence of absence.



### Benefits missing for the rich

Then, why is it that so many citizens still wish to stay away from this new technology? And why, in Europe in particular, has the technology been so readily stifled through regulation?

The reason is, as seen, not that risks might be present, but that direct benefits for most citizens in Europe and the United States are completely missing.

In both Europe and North America, agriculture is highly productive without GMOs, incomes are high, most people are well-fed, or overfed. Only a tiny slice sees any direct benefits at all from the agricultural GMOs. In the US, the only direct beneficiaries—the cotton, maize and soybean farmers, the seed companies and the patent holders—are less than one percent of the population. For the remaining 99 percent, GMOs don't provide any noticeable direct benefit at all. The products are not better and not noticeable cheaper for the affluent consumer.

It is not the presence of direct risks; it is the absence of direct benefits that affects the attitude.

### The extension to Africa

This wealthy post-agricultural population's perception—“There is nothing here that I need”—ought to be out of place in a poor agricultural society, where farmers are not yet prosperous and consumers not yet well-fed. For example in Africa where 60 percent of the population are

farmers, their productivity is extremely low, and a third of the population, mostly women and children, are chronically malnourished.

In this completely different environment, it would be very inappropriate to transplant a European attitude towards this technology. But that is actually what is happening!

The extension of this approach takes place through at least four different channels, where Africa for post-colonial reasons pays closer attention to Europe than to North America or Asia:

1. *The European foreign assistance programmes* do not provide help in developing agricultural biotechnology, only in regulating it.
2. *Non governmental organizations (NGOs)*, such as Greenpeace and Friends of the Earth, wage campaigns in Africa against agricultural biotechnology—with economic support from the European foreign assistance programmes.
3. *The United Nations Environment Programme/Global Environment Facility (UNEP/GEF)* promotes the drafting of European style biosafety frameworks, with significant purchase in aid-dependent Africa.
4. Most African governments are dependent on export earnings of *commodity trade* to Europe, and the European importers have signalled that trade with agricultural products might terminate if Africa starts planting GMO varieties.

What Africans are really concerned about

isn't really biosafety or food safety risks. They are worried about commercial export risks.

### Inconsistent regulations and attitudes

The whole scenario could be understood if the European view was exported to Africa on principle; if people in Europe held a common consistent belief on precaution against GMO. But there isn't such a consistency.

When comparing the attitudes to GMOs in agriculture with the same in medicine—where the vast majority of the European citizens will realize direct benefits—it seems like all these precautions are suddenly set out of principle. Europe has decided to apply extremely strict regulations on agricultural GMO, but not to the use of recombinant drugs in medicine (table 13).

Then, why do European regulators treat GMOs in medicine so different from GMOs in food and agriculture? And why do European consumers accept GM drugs but not GM food? There are a number of possible explanations, of which the first five below will be argued as flawed, while the two subsequent bear some relevance.

Flawed explanations for resistance to GMOs in agriculture:

1. *Evidence of risk*. But there are large known risks with pharmaceuticals, which seem acceptable.

Table 13. Number of recombinant drugs approved until 2008, and people's acceptance of recombinant drugs and foods in 2003 (adapted from Clearant, 2006; the European Medicines Agency (EMA), 2006; and Priest et al., 2003).

	US	EU
Approved recombinant drugs	130	87
Acceptance of recombinant drugs (% of population)	78%	60%
Acceptance of recombinant foods (% of population)	58%	34%

2. *Opposition to genetic engineering.* But recombinant drugs are manufactured using the same engineering techniques as with GM crops.
3. *Inability of people to understand the science.* But people don't understand the science of recombinant drugs any better.
4. *GMOs are patent protected, expensive and sold by multinational corporations.* But that is the same with drugs.
5. *People don't trust regulators.* But there is just as much reason to mistrust the medical regulators.

Valid explanations for resistance to GMOs in agriculture:

1. *Lack of control over exposure.* When one of the first genetically modified agricultural products was introduced in Europe (a soybean in 1996), it was placed on the market without identifying labels, unlike genetically engineered drugs which are carefully labelled.
2. *Environmental release.* Genetically engineered crops are grown in the open environment rather than manufactured under tight containment as pharmaceuticals.

Even though these two arguments may clarify the more hostile reactions to GM foods and crops, they are still not completely valid and convincing. With strict labelling and tracing regulation, genetically modified food can be avoided in Europe today, yet hostility to the technology remains high. And crops developed using mutation breeding—without transgenics—are freely being released into the environment without precautionary regulation.

The correct reason is that the prosperous post-agricultural societies feel that they don't

really need any more agricultural science.

## Opposition groups

In both Europe and North America, active opposition to *all* forms of agricultural science is today on the rise. There are three different but overlapping types of groups, originating in the rich countries:

- *Environmentalists*, regarding all chemicals in agriculture as bad for the environment.
- *Agrarian populists*, opposing all agricultural science—even the green revolution—and fearing further development of large-scale industrial farms, at the expense of small traditional farms.
- *Food purists*, associating science with unnatural and unsafe foods, promoting organically grown foods as a viable alternative.

## If we cared

If people really cared about biosafety, they wouldn't be obsessing about regulating modified crops that have not yet demonstrated any new risks to the environment. Instead, they would work much harder to prevent the destruction of wildlife habitat; they would invest much more in the clean-up of waterways; they would be cracking down on international travel that might contribute to damaging bio-invasions of exotic species; or they would ban the use of agricultural chemicals.

Biosafety is under devastating attack from all of these things, except from GMOs.

But wealthy post-agricultural societies find such measures expensive and inconvenient. So they don't care.

---

### Read more

*Starved for science: How biotechnology is being kept out of Africa.* By Robert Paarlberg. Published in 2008 by Harvard University Press.



# When is food safe enough?

PROF. BRUCE CHASSY

From a safety point of view, food is safe when it does absolutely zero harm. But that is never the case. Food is safe enough when the benefits of eating—be that pleasure or nutrition—far outweigh the damage done by the consumption.

Starvation, poor diets and obesity, food borne illnesses, mycotoxins and natural toxicants are the real food safety risks. With Golden Rice, the

largest risk is not using it, since about 2.5 million people die each year from vitamin A deficiency. This is a classic example of the damage caused by spending enormous amounts of money avoiding hypothetical hazards, while diverting resources and distracting the public from the real food safety risks.

## Hazards, risks and benefits

When discussing safety issues, it might be helpful to differentiate between the terms hazard and risk. *Hazards* refer to hypothetical bad things that might happen with only theoretical risks of harm, while *risks* are bad things that really happen.

Because they happen, risks can be quantified: how likely they are, how much damage they do, etc. One can learn to manage risks. And if there is also a benefit, one may accept living with some of the risks. Risk assessors actually have to make decisions on how many people they are willing to hurt before the benefits are outweighed. With new drugs that is done all the time, but we are less willing to accept that with food.

In general, technologies—like houses or aeroplanes—are not considered safe or unsafe. It is how they are constructed and used that makes them beneficial or harmful, useful or not. In order to assess that, new technologies

must be examined on a case by case basis, just like new phenotypes of GMOs. But if a whole technology is abandoned beforehand, because of some hypothetical hazard it might cause, nobody is going to know which harm actually would have been done by current practice.

We need to balance the real benefits and existing risks against hypothetical hazards that may or may not become real risks. Otherwise, to be truly precautionary, we must never do anything for the first time.

We also have to accept that whenever something is changed, there may be hazards we haven't even thought about.

## Misinterpretation of the precautionary principle

Using the precautionary principle correctly, means seeking a higher level of safety for consumers and the environment.

Some interpretators of the precautionary principle suggest that *to do no harm* is the first principle. And when in doubt do nothing. But that is not what the precautionary principle says!

The fourth condition of the precautionary principle, as stated by the European Commission, reads: “Where action is deemed necessary, measures based on the precautionary principle should be... based on an examination of the potential benefits and costs of action or lack of action (including, where appropriate and feasible, an economic cost/benefit analysis)”<sup>1</sup>.

The EC document clearly states that one should not reject something without considering the consequences of non-adoption. And that tends to be overlooked.



Figure 15. Holes in the maize-corn made by common maize-borer become entrypoints for mould. Two Bt maize cobs to the left and two cobs of conventional maize with insect damage and mould to the right.

## Food safety risks

People face various food safety threats every day; not hypothetical hazards but real risks.

*Food borne illness* caused by bacteria, viruses and parasites is considered the number one food safety problem. WHO has estimated that, in 2005, 1.8 million people died globally from diarrhoeal diseases, largely caused by contaminated food and drinking water.

Diarrhoea is a common cause of malnutrition in infants. Malnourished small children are often vitamin A deficient, and therefore don't develop a functioning immune system to withstand the infections, and so on in a vicious circle. WHO recognizes vitamin A deficiency as contributing tremendously to deaths of food and water borne diseases.

A less commonly known food safety problem is the *mycotoxins*, with aflatoxin B<sub>1</sub> as one of the most potent carcinogens known. Many foods made out of grain or groundnuts are con-

taminated with aflatoxin. The United States and Europe try to control them, but in many parts of the world there is no awareness. Poor harvest and storage conditions promote the growth of fungi producing aflatoxins and other mycotoxins, and there are no means of protecting against them.

As a matter of fact, organic foods often cause higher incidences of food-borne diseases than conventional products, and often also higher levels of mycotoxins. This is because organic farmers don't use synthetic chemicals to stop fungal contamination of crops. On the other hand, GM crops often have lower levels of mycotoxins such as fumonisin (figure 15).

Plants make all kinds of *natural chemical compounds*, so called secondary metabolites, to protect themselves against moulds and insects. Some of them—such as glucosinolates in rape, phytate in maize and solanine in potatoes—are

1. COM(2000)1. See also 'Biosafety in the EU context', page 87.



toxic. According to Bruce Ames<sup>2</sup>, as much as 99 percent of all carcinogens we eat are naturally occurring compounds that the plants make themselves.

When it comes to plant genetics, the likelihood of damage is greater with *conventional breeding* than with gene modification, because DNA is disrupted in much more general and unspecific ways. On a couple of occasions breeding processes have given adverse effects; a potato that had too much solanine; a zucchini squash with too much cucurbitacin; and a celery which had a high concentration of psoralens—all three toxic substances.

This is far less likely to happen with GM crops, as they are the result of a more precise technology. The changes made to DNA are fewer and less dramatic than the changes made by conventional breeding.

### Quantifying the risks

As risks are known and quantifiable, it is possible to calculate the odds of dying from them. And people die of all sorts of reasons.

Being one of the 850 million people<sup>3</sup> around the globe who don't have enough to eat is probably the greatest risk in their day. Obesity is another colossal problem. Because, even when they have enough food, people make bad choices about what to eat, and a lot of deaths are related to choice of diet and lifestyle (table 14).

Understanding these risks quantitatively, and what one can do about them, gives some guidance where we ought to spend our research, regulatory and educational money. And on the contrary, if something doesn't hurt anybody and has no known risks, we shouldn't invest much in regulating and controlling it.

Table 14. The risk of dying by various reasons in the US, 2002 (source: CDC National Center for Health Statistics).

Cause of death	"Chance" of death 1 in ...
Heart disease	397
Cancer	511
Stroke	1699
Accident	3014
Alzheimers	5752
Alcohol	6210
Suicide	12091
Homicide	15540
Food poisoning	56424
Drowning	64031
Fire	82977
Bicycle accident	376165
Airplane	1100000
Lightning	4478159
Bioterrorism (anthrax)	56424800

### How safe is Golden Rice?

The difference between Golden Rice and normal rice is a couple of foreign genetic elements from other species that have been inserted. The food safety assessor's job is to estimate how safe these pieces of DNA are when placed into a different plant. Fortunately, there is a roadmap for these assessments:

- Even if the regulatory systems differ around the world, most of them adhere to the same guidelines, agreed on in a consensus document published by *Codex Alimentarius*<sup>4</sup> in 2003.

2. Paracelsus to parascience. By Bruce N. Ames and Lois Swirsky Gold. Published 2000 in *Mutation Research* 447. 3–13.

3. Since the increase in world food prices in 2007/2008, the Food and Agriculture Organization (FAO) has estimated that the figure has risen to around 925 million.

4. The *Codex Alimentarius* is a collection of internationally recognized standards, codes of practice, guidelines and other recommendations relating to foods, food production and food safety, developed and maintained by the Codex Alimentarius Commission, a body that was established in 1963 by FAO and the World Health Organization (WHO).

- The International Life Sciences Institute<sup>5</sup> (ILSI) has developed a framework described in *ILSI 2004* and *ILSI 2008* for nutritionally enhanced foods and feeds.
- The Organization for Economic Cooperation and Development (OECD) has published a series of consensus documents that describe the typical composition and nutritional value of many crops.

Scientifically there is broad consensus on what the safety issues are and what kind of data is needed to satisfy these issues. Regulatory agencies all over the world can use the same dossier of information, because all the regulatory scientists speak the same Codex Alimentarius language.

Some principal questions need to be answered:

- Is the DNA safe?
- Is the protein it encodes for safe?
- Have there been any unintended changes in composition or other undesirable changes in phenotype?

In Golden Rice, one of the new proteins comes from an edible plant—maize or daffodil, and the other comes from a bacterium, *Erwinia uredovora*. Their safety has to be assessed. It will also be necessary to evaluate the levels of carotenoids and related compounds as well as the overall composition of the rice. For Golden Rice, these analyses have turned out to be quite simple, and ILSI has concluded its work in three recommendations:

1. *Food safety assessment.* Specific analyses could include: characterization of the inserted DNA; characterization of the new proteins (post-translational modification); digestibility (in vitro) of carotene desaturase; composition analysis; and carotenoid metabolite pool analysis.

2. *Efficacy assessment.* The prediction that Golden Rice can improve vitamin A nutrition needs to be tested in premarket studies on humans, including palatability and acceptance of this rice with its altered appearance.

3. *Risk assessment.* Any potential risks that may be identified with Golden Rice should be balanced against its potential to reduce the loss of life and clinical symptoms of vitamin A deficiency. The magnitude of this potential nutritional impact will only be known for certain after the Golden Rice is adopted.

It must be remembered that it is not yet proven that Golden Rice will work. Until the rice is being fed to people, we cannot know for sure how much vitamin A deficiency it will ameliorate.

### Keeping the perspective

When considering GMOs, it is important to keep risks in perspective.

Dietary sufficiency, adequacy and over-nutrition entail the highest risks, followed by food borne illnesses. Others are untested organic and natural foods and supplements, natural toxins and mycotoxins. For several of these problems, biotechnology could be part of the solution (table 15).

Although there is much popular concern about chemical additives, pesticide residues and GMOs, these are far down on the scale of real risk. Transgenic crops are over-regulated.

There are no obvious food safety risks associated with Golden Rice. Its safety assessment and approval should be straightforward. It is inconceivable that any unforeseen risk of Golden Rice consumption could result in the millions of deaths that will result if it is not deployed.

5. The International Life Sciences Institute (ILSI) is a non-profit, worldwide foundation established in 1978 to advance the understanding of scientific issues relating to nutrition, food safety, toxicology, risk assessment, and the environment.

We are experiencing a situation with respect to Golden Rice, and GMOs in general, that can be called damage by distraction: *“putting huge amounts of money into miniscule hypothetical risks damages public health by diverting resources and distracting the public from major risks”*<sup>6</sup>.

If there was serious concern about well-being in the world, the resources being wasted on regulation and tests could be providing clean drinking water for the two-thirds of the world population that don't have access to clean drinking water. Or it could be used to buy food for the needy. We need to get our priorities in order with reality.

Table 15. Food safety risks in perspective.

**High risk**

Diet: sufficiency, adequacy, over-nutrition\*

Food borne illness\*

Untested: organic, “natural” foods, supplements

Natural toxicants\*

Food allergy\*

Chance additives

Pesticide and herbicide residues\*

Food ingredients and additives\*

GM foods\*

**Low risk**

\* Biotechnology can be part of the solution

---

6. Paracelsus to parascience. By Bruce N. Ames and Lois Swirsky Gold. Published 2000 in *Mutation Research* 447. 3–13



## Achieving risk-based regulation: science shows the way

PROF. HENRY MILLER

National and international regulation of GMOs is unscientific and illogical, a lamentable illustration of the maxim that bad science makes bad law. Instead of regulatory scrutiny that is proportional to risk, the degree of oversight is actually *inversely* proportional to risk. The current approach to regulation, which captures products for case by case review on the basis of the techniques used to construct them rather than their properties, has been costly in terms of economic losses and human suffering.

A model protocol, the “Stanford Model”, is designed to assess risks of new agricultural introductions—whether or not the organisms are “genetically modified”. It offers a scientific and rational basis for field trial regulations. Using such a model for risk assessments would not only better protect human health and the environment but would also permit a more expeditious development and diffusion of new plants and seeds.

### Biotech is not new

Over many millennia, there has been a virtually seamless continuum of genetic improvement of crops with increasingly sophisticated techniques (figure 16). Recombinant DNA modification was introduced as part of this progression of technologies during the 1970s.

Therefore, “genetically modified organism”, or GMO, is an unfortunate choice of terminology. Defined arbitrarily as organisms containing genes transferred across species lines—but only when accomplished by recombinant DNA techniques—it ignores that genetic modification is achieved using many technologies and that recombinant organisms are not a meaningful category.

Millions of new genetic variants of plants field tested each year are derived from wide-

cross hybridizations, in which genes have been moved across species or genus barriers. There are thousands such “non-molecular transgenic varieties” (as they might be called) in commerce around the world. Some examples are:

- *Triticum agropyrotriticum*, a man-made “species” that resulted from combining genes from bread wheat and a grass called quackgrass or couchgrass, that contains all the chromosomes of wheat and one additional whole genome from the quackgrass.
- Triticale, also a man-made grain; a wheat-rye hybrid.
- Pluot, which is a plum-apricot hybrid.

All along, from field testing through scaling up and commercializing to being fed to animals and humans, neither regulators nor activists were concerned with whether the tens

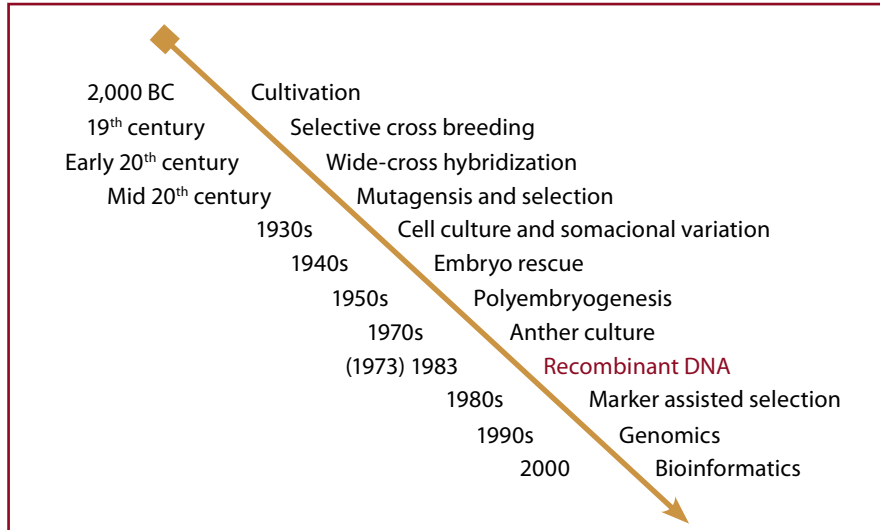

Figure 16. Genetic improvement of crops is a continuum almost since the origin of agriculture, with more and more sophisticated methods developed during the last century (source: M. McGloughlin, 2001).

of thousands of genes from a quackgrass would make *Triticum agropyrotriticum* more weedy or whether any of the expression products were toxicogenic or allergenic. Nor has the pluot received any regulatory scrutiny or resistance from activists.

By contrast, if someone were to move a single gene from quackgrass into *Triticum*, or from plum to apricot, using recombinant DNA techniques, those constructions would be subject to

expansive, extensive and debilitating regulatory regimes.

Most agricultural crops are the products of hundreds, if not thousands, of years of genetic improvement. Figure 17 shows maize, which has undergone drastic modification, from the original grass-like plant with primitive and meagre kernels, into modern maize, with regularly arranged kernels full of carbohydrate, oil and protein.



Figure 17. Teosinte (left) is the precursor of modern maize. Over many centuries, it got developed into a highly modified but much more useful version (middle), still very different from the modern pre-recombinant DNA varieties of maize (right), full of carbohydrate, oil and protein (source: N. Fedoroff, Pennsylvania State University).

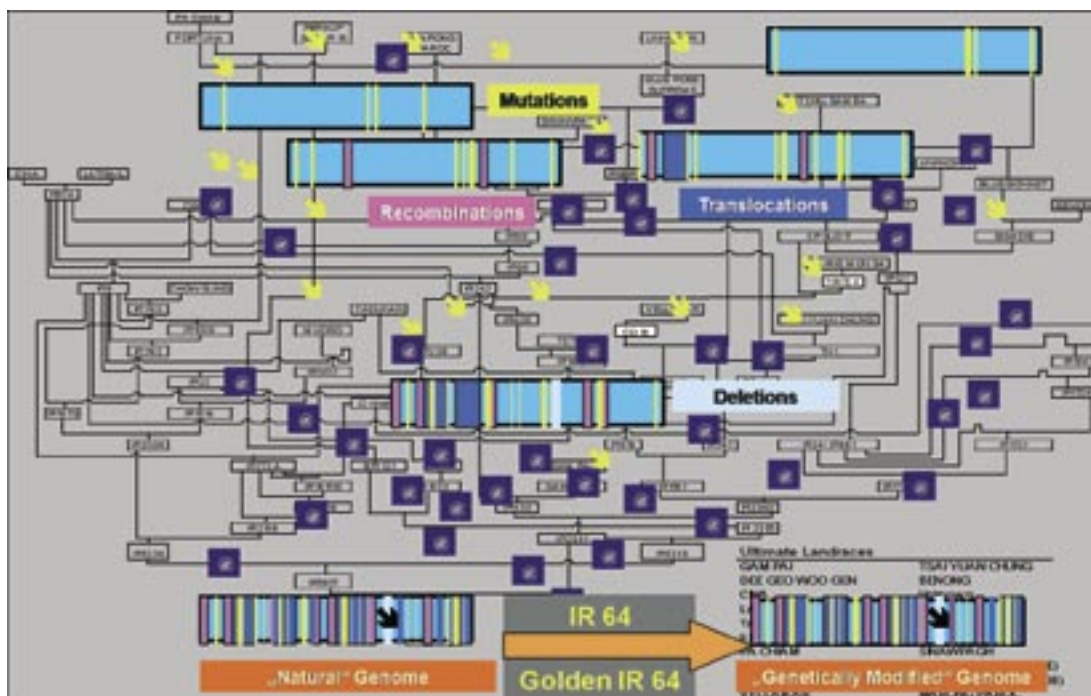

Figure 18. IR64 is developed through extensive engineering by conventional techniques. The yellow bars show the sites for mutations; the purple bars show recombinations; the blue bars translocations and the grey bars the sites for deletions of genes. At the bottom left is the complete so called “natural genome” for IR64, and at the bottom right the “genetically modified genome” with the two additional Golden Rice genes; the black arrow pointing out the site.

Figure 18 shows the entire “pedigree” of IR64—a strain of rice widely grown in many parts of the world—as well as the addition of the foreign genes that transform IR64 into Golden Rice. In spite of the innumerable, sometimes drastic genetic alterations that led to IR64, regulatory regimes regard IR64 as “natural” and, therefore, not requiring regulatory review, while the insertion into precisely characterized sites of two well-characterized genes that enable the plant to synthesize beta-carotene, the precursor of vitamin A, precipitates the burden of regulatory costs and delays.

In other words, “GMOs” (or variations on the theme) are not a genuine, meaningful category.

## Benefits and obstacles

Recombinant DNA modified plants have shown extraordinary potential:

- *Increased yield*, which permits greater utilization of cultivated land.
- *Decreased use of chemical pesticides* leads to less runoff and fewer poisonings. For example in China, the use of Bt cotton has substantially reduced poisoning incidents by pesticides amongst farmers and their families.
- *Reduced water requirements* with drought-resistant or saline-tolerant varieties may be among the most important applications world-wide. With future recurrent droughts over southern Europe, Australia, parts of the United States and much of sub-Saharan

Africa, even small improvements in water requirements can make a large difference in yields and cost-effectiveness of farming.

- *Shifts in herbicide usage* lead to more environmentally friendly herbicides and increase of no-till farming with lower soil erosion, less run-off and less carbon dioxide release to the atmosphere.
- *Decreased content of fungal toxins* in food and feed.

In spite of these benefits, many of which have already been realized, the technology has encountered various obstacles. A number of pseudo-crises—stirred up by fear-mongering non governmental organizations, one-sided journalism and the expansionist tendencies of bureaucrats—have led to flawed public policy and over-regulation of the whole technology and its products.

### Principles of regulation

There are certain principles of regulation that any regulatory scheme should honour:

- The degree of regulatory scrutiny should be commensurate with level of risk.
- Similar things should be regulated in a similar way.
- A principle more specific to recombinant DNA modification was formulated by the US National Research Council in 1989: *“The product of genetic modification and selection should be the primary focus for making regula-*

*tory decisions... and not the process by which the products were obtained”.*

- Moreover, if the scope of regulation—i.e. the regulatory net or the trigger that captures products, field trials or the finished food—is unscientific, then the entire approach is unscientific.

All these principles of regulation have largely been ignored. The current regulatory regimes are unscientific, process-based, and require case by case review for virtually all recombinant DNA modified plants and microorganisms, no matter how obviously trivial the modification or benign the product might be.

### Consequences of flawed regulation

The current flawed regulatory approach, which categorically ignores fundamental principles of regulation and the dictates of common sense, results in enormous costs, lack of agricultural progress and human suffering.

#### Increased research and development costs

The compliance costs of regulation for the development of an insect-resistant and a herbicide-resistant maize have been calculated to be between USD 6 and 15 million respectively, not including labelling<sup>1</sup>. This is several times more costly than for similar constructions made with conventional breeding, in spite of the latter being less precise and predictable.

*“Gene modification is not new”*

*“Risks of recombinant DNA modification can be assessed and managed with current risk assessment strategies and control methods.”*

– WHO Regional Office for Europe, 1982

*“Crops modified by molecular and cellular methods should pose risks no different from those modified by classical genetic methods.”*

*“As the molecular methods are more specific, users of these methods will be more certain about the traits they introduce into the plants.”*

– US National Research Council, 1989

1. *Economic and environmental impacts of agbiotech: a global perspective*. By N. Kalaitzandonakes (ed). Published in 2003 by Kluwer-Plenum Academic Publishers; Included in work by a research group at the University of Missouri, Columbia.



Fewer products in the pipeline with reduced benefits for farmers and consumers

The costly and uncertain regulatory milieu has inhibited agricultural innovation and product development, decreased commercialization of already developed recombinant DNA modified crops and decreased the potential for new, improved varieties of fruits and vegetables, tree fruits and nuts, and nursery and landscape crops.

In 2007, the total area of biotech crops was around 110 million hectares. Nobody has yet tried to calculate the economic losses, but with a more rational, science-based regulation there would be far more acreage farmed, traits developed and species in commercialization. Putting it another way, the opportunity costs of flawed, unscientific public policy have been enormous.

#### Pseudo-crises and litigation

Pseudo-crises have led to public relations debacles, flawed public policy, endless discussions over inconsequential issues like coexistence, tolerance and labelling, as well as costly court trials. One well-known example is the StarLink case where the US Environment Protection Agency gave split approval of maize for animal but not human consumption, but later detected it also in human foodstuffs. The regulatory and civil penalties to the company that made the StarLink for this inconsequential “transgression” were substantial. Other pseudo-crises include the alarms over killing of Monarch butterflies and the contamination of land races in Mexico. All of these are based on inaccurate or fraudulent reports, or results taken out of proper context.

#### Vandalism and intimidation of academics

Field trials are constantly being vandalized, because the regulatory requirements entails the sites of trials becoming publically known.

Researchers have been injured, research destroyed, and in Germany, two universities recently responded to the threats of activists by banning the testing of recombinant DNA modified plants; in fact, an appalling abdication of the academic freedom.

#### Malnourishment, illness and deaths

Malnutrition claims 24,000 lives per day; many of which could be saved if Western societies would change their hostile attitudes and policies towards recombinant DNA modification.

### The Stanford Model

It is easy to complain about the unscientific, non-risk-based regulatory regimes. But there is an alternative. In the 1990s, a model for risk-based regulation, the Stanford Model, was developed.

The Stanford Model was devised to stratify all risks that can occur in field trials (figure 19). The large triangle represents the entire universe of all field trials. This universe can be divided in two ways:

- Horizontally, according to risk categories, higher risk being at the top of the pyramid.
- Diagonally, according to technology, the green area is all field trials performed with organisms created by conventional breeding or tissue culture, while the area to the far right corresponds to field trials with recombinant DNA modified organisms.

Conceptually, it should be clear that there is no enrichment of risk that is a function of any particular technology. There can be worrisome organisms—for example foot and mouth disease virus, African killer bees, rusts that infect grains, or kudzu—that require more caution in field tests whether they are modified or not. Plants may be invasive, produce potent toxins, etc., but in general they are of negligible or low

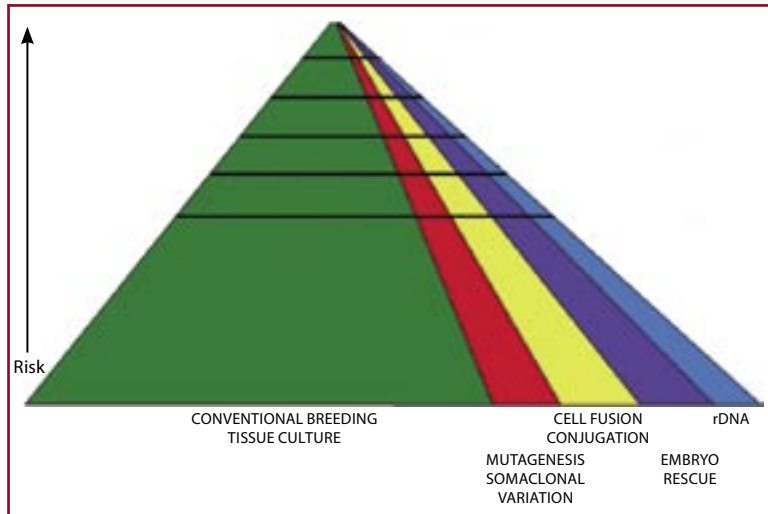

Figure 19. The Stanford Model for assessing risks of new agricultural introductions. The horizontal lines mark risk categories with higher risk towards the top, and the diagonal (slanting) lines divide according to technology.

risk. Recombinant DNA modification has no particular monopoly on safety, but on average, it is more precise and more predictable than the other techniques.

The Stanford Model has several advantages:

- It stratifies all organisms according to risk and is indifferent to the technique (if any) of genetic alteration.
- It is flexible.
- It is scientifically defensible.
- It permits various degrees of risk-aversion depending on the need.

- It permits discretion—in a scientific context.
- It exempts field trials that should be exempt and captures field trials that warrant review.

One great advantage is that it is analogous to existing regulatory regimes, such as those for quarantine regulations for plant or animal pests, and also to the approach at least in the United States for handling dangerous pathogens or other microorganisms in the laboratory.

#### Read more

A model protocol to assess the risks of agricultural introductions; A risk-based approach to rationalizing field trial regulations. By John Barton, John Crandon, Donald Kennedy and Henry Miller. Published 1997 in *Nature Biotechnology* 15, pp 845-848. [www.nature.com/naturebiotechnology](http://www.nature.com/naturebiotechnology)

*The Frankenfood myth: How protest and politics threaten the biotech revolution.* By Henry Miller and Gregory Conko. Published 2004 by Praeger Publishers.

*Mendel in the kitchen: a scientist's view of genetically modified foods.* By Nina V. Fedoroff and Nancy M. Brown. Published 2004 by National Academies Press.

# Golden Rice and progress towards GMO-deregulation

DR. GERARD BARRY

In a global context, Golden Rice is surrounded by progress on gene modified foods, feed and other products. Country leaders are eagerly awaiting the biofortified crops as a new effective means in the fight against vitamin A and other micronutrient deficiencies.

Going through the process towards deregulation of Golden Rice, this presentation is pointing out practical steps to accelerate the progress and scopes for harmonization and standardization of the regulatory requirements.

## Surrounded by progress

A number of countries have approved GM crops, like cotton, maize and soybean. Several other GM food crops, fruits and vegetables are rapidly advancing towards commercialization. Pharmaceutical products are being developed out of rice, such as an oral rehydration treatment against infantile diarrhoea (Peru and the US) and an antigen to be used as vaccine against cedar pollen allergy in Japan.

The leading countries have policies conducive to modern biotechnology. Their governments, scientists and regulators believe in it and want to use it for their national benefits.

Vitamin A deficiency remains a large problem in many countries and leaders are eagerly awaiting the introductions of the biofortified foods.

Golden Rice is progressing towards commercial release in 2011 or 2012 (figure 20). Nine events (three GR1 with carotenoid levels up to eight micrograms per gram, and six GR2 with carotenoid levels up to 25 micrograms per gram) are in breeding projects being crossed

into popular varieties for the Philippines, India, Vietnam, Bangladesh and Indonesia<sup>1</sup>.

## Practical steps

The regulatory requirements for each and every new variety of gene modified crops can appear daunting. But this is the situation, and there are a number of practical steps which makes the process easier.

### Interactions with the government

The *attitude of the government* is central. The Philippine government has a history of supporting the use of modern biotechnology for national development and of approving GM crops. The first one was approved in 2002. The government acts seamlessly and relies on its scientists to do all the reviews and give advice, and the scientific panels are anonymous.

In the Philippines, where VAD is extremely high, the government sees a critical need for alternative interventions such as Golden Rice. The trait will be bred into the

1. See 'Biotechnology in agricultural programmes in developing countries', page 37.

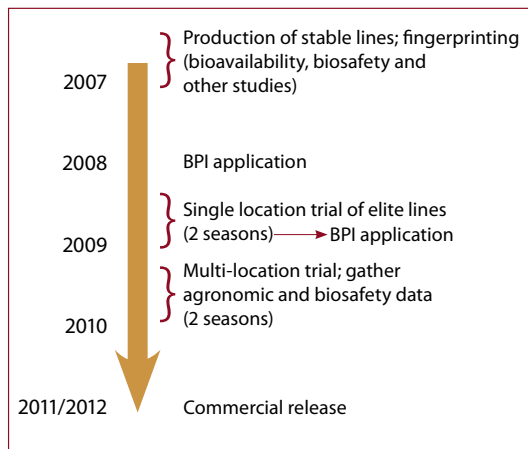

Figure 20. Timeline towards commercialization of Golden Rice in the Philippines (source: A. alfonso, PhilRice).

most popular Rc82 variety, which grows well all over the country. As the variety is already on the market, the Philippine regulators have decided that the variety itself may not have to be registered again, only the transgenic event will go through the standard, transparent review process.

#### Interactions with the regulator

It is important to have *early interactions with the regulator*. Early information and decisions on what studies will be needed for the risk assessments helps in planning and budgeting.

Regulators always like to know if somebody else has worked on the same crop. For them (and for the public), previous experiences drawn from other countries are helpful. The International Life Sciences Institute (ILSI) has given guidance on analyses for nutritionally enhanced bio-fortified transgenic crops. The Organization for Economic Cooperation and Development (OECD) has templates of what parameters to analyse. Also Codex Alimentarius has recommendations.

In certain countries, *agronomic suitability* is an issue. Irrespective of biosafety, the regulators will also assess if the material is suitable for the farmers in the intended area. The regulatory bodies will not approve a new variety unless it is adapted.

One new factor is submergence tolerance; for example, unless the varieties grown along the Sunderbunds in eastern India and Bangladesh have submergence tolerance, some years the farmers may not have much of a harvest.

#### Suitable events

The Golden Rice events being worked on are *single locus events*, they are intact and the insertion sites and the flanking sequences are known. This saves the regulators from trying to assess bits and pieces of multiple loci, and worrying about running into side sequences or having created new genes. It is also of value for the breeder, as for example with partial sequences, at every meiosis there would be a risk of recombining and losing the trait. Also the events are *very stable* (the events have been selected from nearly 2,000 independent transgenic events in multiple generations where unstable ones, etc. were discharged).

Eventually only one Golden Rice event will go through the regulatory process.

#### Incentives for farmers

In addition to the transfer of the beta-carotene loci into important, popular varieties, Golden Rice will be complemented with *as much benefit as possible* into the new release. It will be enriched with the other important micronutrients zinc and iron, where International Rice Research Institute (IRRI) already has made the crosses.

There is no economic *incentive per se for farmers* to grow Golden Rice. Therefore, to drive farmer adoption, PhilRice in the Philippines

is combining Golden Rice with two conventionally bred resistant varieties—tungrovirus and bacterial leaf blight resistance. And this will have to go through a new varietal approval process. But the testing for varietal and biosafety approvals goes on in parallel.

#### Isolation of field tests

Isolation for field testing may be costly arrangements. In the Philippines, *temporal isolation* from the same kind of crop is a major component of risk management for early, small scale trials, with less reliance on physical isolation. It is a low-cost measure mitigating against pollen spread, etc., still with very good risk management (figure 21). After harvest, the field is left as *fallow for a season* and anything coming up gets ploughed in.

#### Health concerns

Increasing the level of allergenicity of a food by inadvertently adding a gene for an allergenic protein is a common concern for the regulators and the public. They want to be sure there isn't an allergen inserted into Golden Rice.



Figure 21. Temporal isolation of a field trial in the Philippines, 2008. In the foreground field test with young Golden Rice plants; behind a strip of maize and in the background rice fields with rice soon ready for harvest.

Today, there is a lot of knowledge about allergens. There is scientific consensus on what is an allergen and not depending solely on homology. For example, allergens are very stable in the gut, while the proteins in Golden Rice have proven to degrade quickly.

The Bt gene has been claimed by opponents to the technology to be an allergen. But because of the regulatory requirements for GMO, the Bt proteins have been studied in multiple crops and countries, and it is not in any case found to be an allergen.

The Food Allergy Research and Resource Program (FARRP) at University of Nebraska-Lincoln runs a website offering scientific information, including a curated collection of known allergen sequences.

#### Harmonization of regulations

Unfortunately, it is difficult to get countries to harmonize their regulations. However, in fact, depending on what trait and to various depths, all regulators ask the same questions. They need information on the parent crop; they want to know the donor, the transgene and the delivery process; they ask for the characterization of the gene products; and eventually they need to assess the new modified crop (figure 22).

#### Parent crop

In the US, when submitting a regulatory document and there is an OECD consensus document on the parent crop, that can be used. The Philippine government has accepted the two OECD consensus documents on rice, which solves the whole issue of parent crop information.

It is important to get this background information standardized, because when assessing a crop that is substantially equivalent except for the intended changes, this becomes the refer-

ence. And instead of relying on single studies, the OECD data contains the natural variation in rice as a food and a feed (figure 22a).

#### Donor, transgene and delivery process

The data needed for donor, transgene and delivery process, as well as for characterization of the gene products are not event-specific, and most documents have been produced already. For a new variety, it is in practice all paperwork (figure 22b).

#### Safety assessment of new GM crops/food

Most data for the assessment of the new crop do not change because it is grown in another country. Therefore, if the crop is tested before, most of the data already exist (figure 22c).

## Testing of Golden Rice

Table 16 shows the regulatory requirements for Golden Rice in the Philippines. The regulators there have accepted to use experiences from other countries.

The genes in the various Golden Rice events encode for the proteins daffodil phytoene synthase; maize phytoene synthase; *Erwinia* phytoene desaturase and the marker *E. coli* phosphomannose isomerase.

These and related genes have been field tested in various crops such as rice, mustard, maize, peanut, banana, oil seed rape, etc. in many different countries. The leading Golden Rice events have been field tested in the US, and green house evaluations have been conducted in Switzerland, Germany, the UK, the Philippines, India, Vietnam and Bangladesh.

Figure 22. A fully integrated approach to the hazard assessment and characterization of all elements involved in producing a new GM variety (adapted from König et al., 2004. Food and Chemical Toxicology 42: 1047–1088).

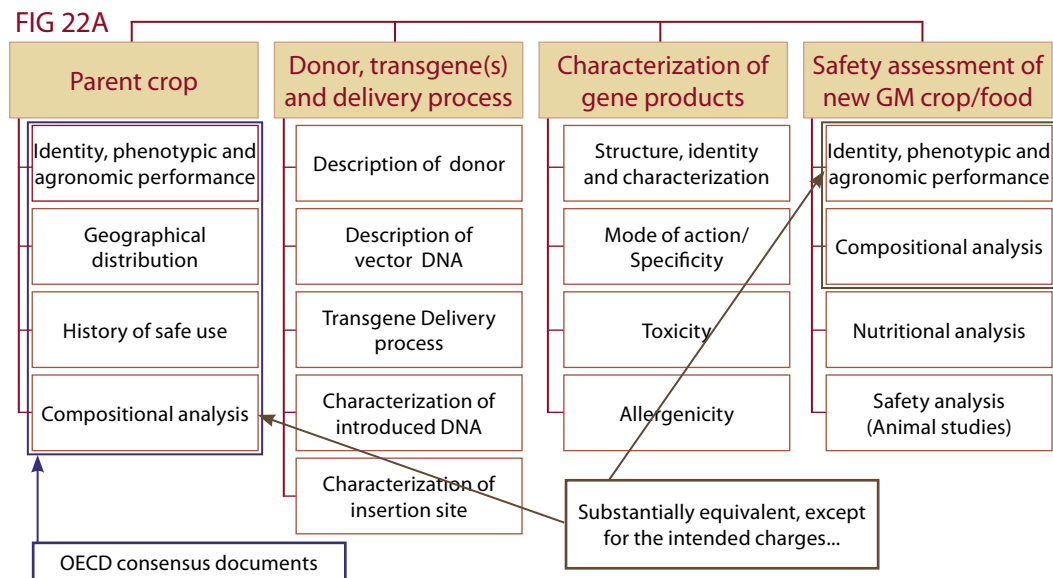

FIG 22B

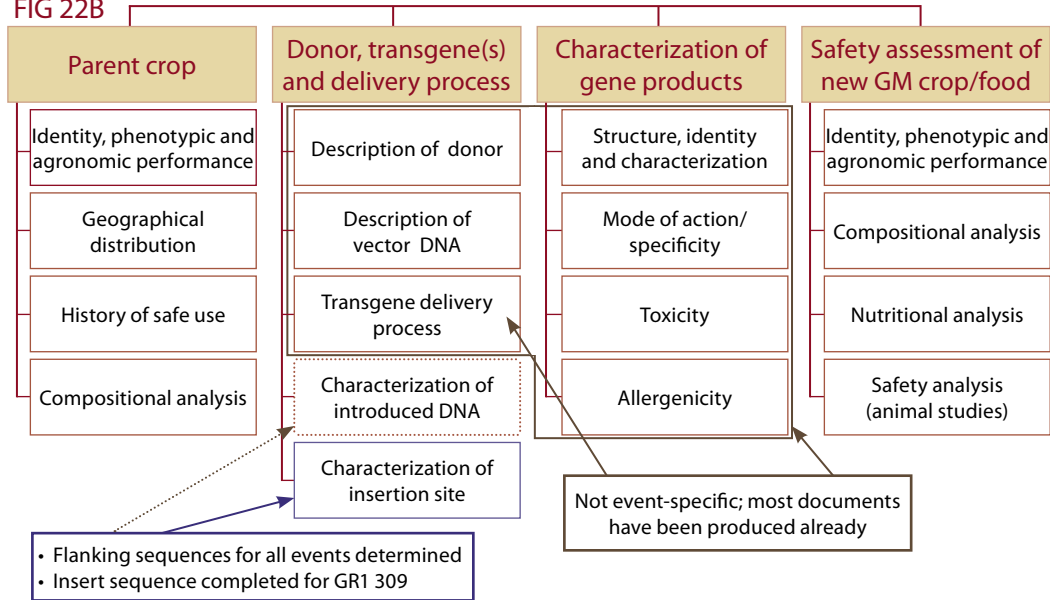
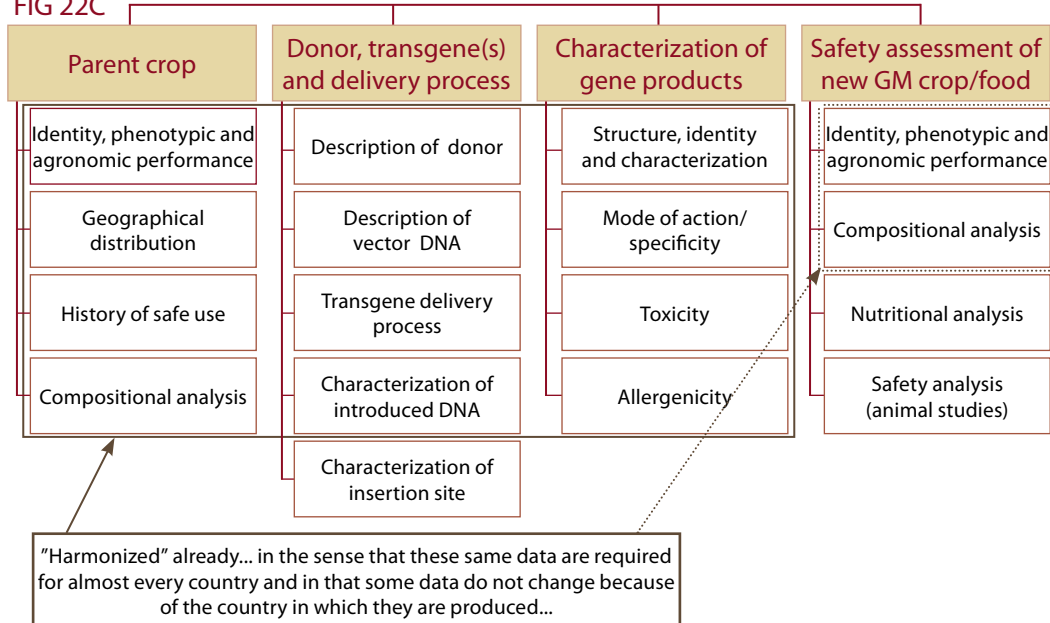

FIG 22C



The marker has been studied in several field trials, and is included in a commercially approved transgenic maize variety. The GM maize with this marker has been through a lot of regulatory processes, it has been approved for food and feed and is widely used in several countries, such as Japan, Canada, Australia, Korea and Mexico.

Studies trying to identify matches between the proteins in GR1 and GR2 and known allergens, using the Allergen Online database, have come to the conclusion that ‘from these observations, the novel proteins introduced into GR1 and GR2 are not expected to have any significant risk of cross reactivity for those who are allergic to known allergens’.

### Share data!

A simple harmonization is to share the data sets. If it doesn't have to be repeated in the country—don't do that! That removes the burden and uncertainty, by compartmentalizing a lot of the information that does not have to be generated anew, just because the material has crossed the border.

Table 16. Regulatory requirements for Golden Rice in the Philippines.

- **Existing regulatory experience and consumption in other countries**
- **Inserted sequences**
  - Source of genes, transformation method, insert details (intactness), genetic stability
- **Proteins**
  - Expression levels in plant tissues and consumed portions, homology to toxins, allergenic potential
- **Some assays**
  - Digestibility
  - Heat stability
  - Homology to toxins and allergens
  - Acute oral gavage
- **Nutritional data (food and feed)**
  - Proximates, key nutrients, anti-nutrients
  - OECD options
  - ILSI options
- **The plant in the environment**
  - Biology, consequences of outcrossing, weediness potential, (levels of the expressed proteins)
- **Secondary/non-target**
  - Storage insect pest—weevil

---

#### Read more

[www.allergenonline.com](http://www.allergenonline.com) Food Allergy Research and Resource Program (FARRP) Protein Allergen Online Database

[www.goldenrice.org](http://www.goldenrice.org)



# The political situation for biotechnology

Governing agricultural biotechnology in Africa, p 83

Biosafety in the EU context, p 87

Can bioscience support agricultural progress in developing countries?, p 93



# Governing agricultural biotechnology in Africa

PROF. JUDI W. WAKHUNGU

The role of biotechnology is as much debated in Africa as elsewhere, with strong voices for and against. As a new challenge for the policy makers, the public is becoming thoroughly involved.

Governance arrangements are being set up primarily at national and regional levels. Due to the fast progress of bio-science, the formal bio-safety mechanisms have difficulties following

pace, leading to informal channels for authority. But the scene is evolving rapidly; the debates are becoming more robust as more credible information is brought forward.

The capacities need to be strengthened at all levels, for Africa to have the authority over its own debates and the Africans to make their own choices.

## Debates and trends

The role of modern biotechnology in African economies has become a subject of debate, and also of controversy. Many interest groups are engaged, such as environmental pressure groups (both large international and home-grown African), consumer organizations, multinational corporations, small-scale industry, farmer organizations, the public research system, and the government ministries and its secretariats. Not even the government ministries within one country have one single view on how—or if—to adopt the new science. For instance, ministries of agriculture and of science and technology tend to have a pro-biotechnology stand, whereas ministries of environment and of health tend to be anti-biotechnology. Also within one ministry, various secretariats may have different views.

Generally, the pro-biotechnology debate focuses on the potential benefits of improving

food security, alleviating poverty and protecting the environment. The anti-biotech groups associate the developments with corporate exploitation and argue that the potential risks to human health and the environment are too high.

As a new challenge for the policy makers, the public is becoming extremely active in the process. This trend is unprecedented in sub-Saharan Africa. Consumers today have access to information and are able to challenge their own governments on the policy-making process and the drafting of biosafety bills. Therefore, public awareness and public information have become extremely important components when putting biotechnology and biosafety mechanisms in place.

In any case, the African countries are increasingly becoming part of the “biotech revolution” and progressing with GM crops—the leader being South Africa with the adoption of Bt maize, cotton, and soybean. Recently,



Burkina Faso has approved Bt cotton and Egypt Bt maize for commercialization. Several other countries, such as Kenya, Uganda and Zimbabwe, have carried out trials on GM crops, especially on Bt maize and cotton.

### Overview of governance arrangements

Governance here broadly refers to *the decision-making instruments, the institutions and the principles* regulating and managing modern biotechnology. The governance arrangements for biotechnology in Africa function at three main levels: the global, the regional and the national, with mechanisms at the regional and national levels taking precedence.

At the global level, all countries are obliged to comply with international agreements for biotechnology, in particular the Cartagena Protocol on Biosafety.

At the regional level, governing biotechnology is evidenced by harmonization efforts, driven by the regional economic communities such as the Common Market for Eastern and Southern Africa (COMESA), the Southern

Africa Development Community (SADC), the Economic Community of Western African States (ECOWAS), and supported by the African Union (AU) and the New Partnership for Africa's Development (NEPAD).

At the national level, most countries were facilitated by the United Nations Environment Programme/Global Environment Facility (UNEP/GEF) to develop and implement national biosafety frameworks (NBFs).

### The national level

The national arrangements for biosafety vary from country to country.

In most countries, *the national biosafety frameworks* form the main basis for governing biotechnology. These usually contain regulatory regimes for registration of contained trials, field tests and commercialization of GMOs, mechanisms for monitoring and inspection, and also systems for public awareness and public information.

A number of African countries have formulated their own *biotechnology policies*, generally advocating for maximizing the potential while

minimizing the risks to the environment and human health. Emphasis is placed on:

- promoting biotechnology research and development in order to eradicate poverty, enhance food security and achieve sustainable development.
- building Africa's own capacity to develop and safely apply biotechnology in agriculture, health, mining and industry.
- the adoption and deployment of biotechnology in a science-based manner.

At present, several countries (such as Kenya, Uganda, Zambia, Zimbabwe and Malawi) have adopted national biotechnology policies. A few of them (such as Zambia and Tanzania) have taken a precautionary approach, even rejecting GM food aid in times of acute famine.

Many countries have enacted national *legislations on biotechnology*, and even more have biosafety bills soon in place. Some have applied *explicit* legal regimes with stand-alone biosafety laws (for example Malawi, South Africa, Zimbabwe, Ghana, Nigeria, Mauritius and Cameroon), while others have adopted *implicit* legal frameworks with references to biotechnology incorporated in existing laws. Examples of this are Tanzania, where the Environmental Management Act is also applied to regulate GMOs, and Egypt where subsidiary pieces of biotechnology legislation are incorporated in safety and seed laws.

For most countries, *the institutional structures* take the following forms:

- A competent authority—commonly named national biosafety authority (NBA) or, as in Kenya—the National Biosafety Committee (NBC)—is authorizing approvals of biotechnology products, all from research to commercial use.
- This competent authority is supported by government regulatory agencies, such as the plant health inspectorate, the national

environment management authority, the bureau of standards, and so on.

## Formal and informal structures

To get a good sense of how the biosafety regimes in sub-Saharan Africa function, it is not enough to understand the formal national structures, but also necessary to examine the informal governance mechanisms as they may function in practice. Kenya is here an example of how an overall body may be established as the authority, but when it comes to specific regulatory aspects, informally the specific ministries hold precedence.

One reason for this incoherence is that the bio-technology and regulatory regimes are developing concurrently and therefore the regulations become reactive rather than in tandem with the science. For example Kenya has been working on virus resistant potatoes since 1991, but the biosafety regimes were not established until 1998.

Another reason is missed opportunities for collaboration with the knowledgeable international institutions (such as ICIPE, ICRAF and ILRI); even though the formal linkages are there, in practice the participation between the Kenyan government and national institutions on one hand and the international organizations on the other are weak. Only ILRI has been involved extensively in developing the biosafety framework.

In Kenya, the National Council of Science and Technology created and oversees the national biosafety frameworks. The NBC works under the guidance of this council, which function under the Science and Technology Act of 1980. But despite their formal responsibility, the National Council of Science and Technology and the NBC have no real regulatory authority; they simply give advice. Instead, the ministry

that is part of the NBC holds precedence over the respective areas of biosafety. For example, the Ministry of Trade holds precedence over the Standards Act, through the Kenya Bureau of Standards; the Ministry of Health holds precedence over Kenya Plant Health Inspectorate Services (KEPHIS), and so on.

This ambiguous situation has been challenged in Kenya and is now under debate.

### The regional level

There has been growing concern that African countries lack capacity and technical know-how in all aspects of the modern biotechnology. Therefore, the regional bodies are becoming increasingly engaged.

The regional economic communities COMESA, SADC and ECOWAS have been involved in efforts to harmonize biosafety regulations and guidelines. Particular attention has been given to policies governing food aid, regional trade in agricultural commodities, and the effects of asynchronous or different policies.

One major effect of the harmonization is its contribution to building capacity at regional level, thereby forming a basis for the creation of centres of excellence. Other envisaged benefits would be:

- minimized costs by avoiding duplication of testing and streamlining approval procedures.
- mitigation of negative impact on trade and access to emergency food aid—of special concern to land-locked countries.
- enhanced sharing of information, and better coordination of regulatory approvals and transboundary movement of GMOs.

### Enhancing governance

Certainly the debates have become more robust as more credible information has been brought up by the various interest groups. Still, where governance instruments have been formulated and adopted, the human capacity and institutional arrangements for implementation and enforcement are weak. There is high need for robust, credible and science-based governance regimes for biotechnology.

Africa needs to strengthen some critical capacities:

- Building scientific capacity and infrastructure to assess and manage biotechnology-related risks and benefits through national, regional and continental institutions so that all biotechnology policy is informed by the best available research and knowledge.
- Promoting public awareness of, and engagement in, biotechnology dialogue.
- Engaging politicians and high-level policy makers to foster science-based decision-making.

To enhance the governance of modern biotechnology in Africa, the issue must be thoroughly incorporated in the regional economic integration and trade agenda, for example through supporting the emergence of regional innovation systems and centres of excellence.

The emerging regional communities need to identify ways of improving cooperation with other regions in the world, particularly with Asia and Latin America that face similar challenges related to governance of biotechnology.

A main goal must be to ensure that the best knowledge is headed by Africans from sub-Saharan Africa. Ideally, we must strive to foster an African voice on these issues, whether it is for or against.

## Biosafety in the EU context

MR. MARK CANTLEY, SPEAKING IN A PERSONAL CAPACITY

Europe has pursued and been trapped into a conservative approach to biotechnology regulation, which is doing grave damage to research and innovation, investment, competitiveness and trade, as well as to progress in the developing countries.

The Precautionary Principle and the term “biosafety” have been repeatedly misused and

become obstacles to much needed action, and campaigners use the term “biotechnology” as an excuse for all sorts of political opposition.

But the EU Commission might be forced to change track, encountering risks of enormous economic losses when the rest of the world turns toward GMOs.

### Modern biotech and European policy responses

Although modern biotechnology made some significant interventions in 1973, the rapid expansion of knowledge and technique builds on long-established work, embracing all the life sciences and reaching deep into other disciplines and sectors (box p. 88). A lot of the strong industries in agriculture and forestry, plant breeding and crop protection, food processing, pharmaceuticals and chemistry are based on this.

In the 1970s, Europe carried out significant public-financed research on biotechnology. There was an active debate on safety issues on both sides of the Atlantic. From first taking a rather strict stand, it continued in the late seventies and eighties with the view that the early assessments of risks had been exaggerated and that modern biotechnology was not leading to any risks different from those already addressed by existing regulatory structures.

In the US, the first version of the National Institute of Health (NIH) Guidelines came out in 1976, directing biosafety practices and control measures for recombinant DNA research. Two years later, DG Research started work on a proposal, which after several turns was adopted as a Council Recommendation in 1982 (82/472), simply stating that those undertaking recombinant DNA research should notify their national authorities.

In 1978, DG Research established the Forecasting and Assessment in Science and Technology (FAST) group of scientists, which in 1982 published ideas of a “bio-society”, emphasizing the importance of modern biotechnology and the need to facilitate its development and diffusion in Europe. The first research programme on biotechnology was adopted the same year, and has continued within the “framework programmes”—we are currently implementing the seventh. However, coordination between the directorates-general has been weak

The re-discovery of Mendel's work in 1901\* and the publication of the (draft) human genome in 2001 bracket a century of continuing progress in basic genetic science, summarized by Francis Collins *et al.* in *Nature* in 2001:

*"The scientific progress made falls naturally into four main phases, corresponding roughly to the four quarters of the century. The first established the cellular basis of heredity: the chromosomes. The second defined the molecular basis of heredity: the DNA double helix. The third unlocked the informational basis of heredity, with the discovery of the biological mechanism by which cells read the information contained in genes and with the invention of the recombinant DNA technologies of cloning and sequencing by which scientists can do the same. The last quarter of a century has been marked by a relentless drive to decipher first genes and then entire genomes, spawning the field of genomics."*

or absent on key issues.

Biosafety was at that time not neglected, but simply handled under the usual rules for pathogens, etc.

The year 1986 became a hinge year when the nature of the debate changed. On one side with the US adopting the Coordinated Framework, regulating biotech products under existing legislation and agencies, and OECD publishing the "Blue Book", *Recombinant DNA safety considerations*, recognizing that there is no scientific basis for legislation specific to the use of recombinant DNA organisms. On the other side with Denmark publishing a new national law specifically for GM products; Germany indicating that they had similar plans and the European Commission announcing its intention to prepare a regulatory framework for modern biotechnology.

In 1990, the European Commission adopted its first directives specifically on GMOs<sup>1</sup>.

Scientific assurances from academic institutions and government regulatory committees

about the safety of biotechnology weighed politically light in comparison with campaigning NGOs, and were undercut by incidents leading to consumer concerns. One is the coincidence that shortly after the first GM food was launched on the European market in the mid-nineties (figure 23), the UK government was obliged to admit that its scientific advisers had been wrong—eating meat from cattle with bovine spongiform encephalitis (BSE) could indeed transfer the disease to humans.

The outcome was a *de facto* moratorium on the authorization of new products of biotechnology, imposed in 1998 by a number of national environment ministers (and contrary to EC legislation, but still effectively in place), followed in 2001 by further and more stringent legislation on field release<sup>2</sup>.

This politicizing of the biosafety debate has completely ignored the results of biosafety research in the EC and elsewhere—a review published in 2002 of EC-sponsored biosafety research over 15 years (some 80 projects with

\*) Gregory Mendel 1822–1844, sometimes called "the father of genetics", discovered some natural laws for inheritance of traits. His work was never widely noticed during his lifetime, but was rediscovered by Hugo de Vries and Carl Correns in 1900.

1. 90/219 on the contained use of genetically modified micro-organisms and 90/220 on the deliberate release into the environment of genetically modified organisms.

2. 2001/18 on the deliberate release into the environment of genetically modified organisms, and repealing directive 90/220.





Figure 23. Clearly labelled genetically modified tomato purée produced by Zeneca Seeds (Syngenta) was sold in the United Kingdom at Safeway and Sainsbury from 1996 to 1999. The sales went well until public concern about GM foods in early 1999 forced withdrawal.

funding of EUR 70 million), concluded that there were no significant biosafety problems.

While GM food had become extremely politically sensitive, the GM medicines escaped separate biotech legislation, remaining under existing sectoral regulation. The medical research had led to successful innovations such as industrial fermentation in the production of pharmaceuticals. Therefore, the environment ministers did not wish to have a head-on battle with the powerful industrial, political and consumer interests that wanted continuing innovation in health care.

### The precautionary principle

Much of the regulatory debate on biotechnology at European and national levels—and indeed in the context of UN instruments such as the Rio Declaration<sup>3</sup> and the Cartagena Protocol on Biosafety<sup>4</sup>—defends a conservative regulatory approach to GMOs on the basis of the Precautionary Principle.

But this principle does not have one common global understanding. In fact, a glance at Wikipedia<sup>5</sup> illustrates the diversity of interpretations available. And as the principle has been written into various international instruments, all parties use it to justify any restrictive action they wish to take.

After intensive internal debate on the Precautionary Principle, the Commission published a special communication—the first of this millennium, COM(2000)1. The 27 pages include a three-page summary, encapsulated in six bullet points:

“Where action is deemed necessary, measures based on the precautionary principle should be, *inter alia*:

- *proportional* to the chosen level of protection,
- *non-discriminatory* in their application,

3. Principle 15 of the Rio Declaration 1992 states that: “in order to protect the environment, the precautionary approach shall be widely applied by States according to their capabilities. Where there are threats of serious or irreversible damage, lack of full scientific certainty shall not be used as a reason for postponing cost-effective measures to prevent environmental degradation.”

4. The January 29, 2000 Cartagena Protocol on Biosafety declares: “Lack of scientific certainty due to insufficient relevant scientific information ... shall not prevent the Party of import, in order to avoid or minimize such potential adverse effects, from taking a decision, as appropriate, with regard to the import of the living modified organism in question.”

5. [http://en.wikipedia.org/wiki/Precautionary\\_principle](http://en.wikipedia.org/wiki/Precautionary_principle)

- *consistent* with similar measures already taken,
- *based on an examination of the potential benefits and costs* of action or lack of action (including, where appropriate and feasible, an economic cost/benefit analysis),
- *subject to review*, in the light of new scientific data, and
- *capable of assigning responsibility for producing the scientific evidence* necessary for a more comprehensive risk assessment.”

This writing is full of rational nuances, but it is little known, rarely quoted, and often misrepresented, being replaced by the simplistic—and highly risky—strategy “*if in doubt, do nowt*”<sup>6</sup>.

### Biosafety is a dangerous word

The word “biosafety” is a trap. It is easy to pronounce and may mean more or less anything one cares to make it mean.

The term embraces safety issues on everything related to biotechnological discoveries in the life sciences, leading to the assumption that they could all be thrown into one single regulatory sack; that there should be one generic biotechnology legislation and regulation.

That would mean that all diverse products and services derived from human and animal health, agriculture and food processing, care and management of environment and industrial safety, are associated with one same class of risks. And it ignores the historic track record of similar products and services which, with light or no regulation, have not produced any significant risks—indeed, may have diminished them.

### Campaigns of many reasons

The policy debate on modern biotechnology has

become embittered and polarized, like a mediæval theological dispute. The GMO regulatory issues have become touchstones for a range of positions and beliefs, ever less related to the original issue.

Many of the opposing parties do not understand much about biochemistry, microbiology or molecular biology, and do not want to understand these topics because there is a risk of being captured. They don’t agree that modern biotechnology is continuing the historical progression of scientific understanding and technological applications. They gladly cite the innovators’ own words—especially in defending their claims to intellectual property protection—describing their innovations as “new”, “novel” and “unprecedented”.

These campaigners believe that we can get by without modern biotechnology—and actually stop “the knowledge machine”.

In many ways, the GMO debate has become a convenient rallying point for political campaigns against other issues, such as capitalism, globalization, multinationals, the industrialization of farming and food provision, imperialism, colonialism, the (mis)appropriation of genetic resources and the devastation of environment.

Opposition varies across the world, but typically it includes three main drivers: the campaigning NGOs (especially Greenpeace and Friends of the Earth), the media, and in Europe, the national environment ministers and ministries.

### Wakening up

The Precautionary Principle is much cited, but in practice the carefully defined procedures are ignored. The risks of bans and non-action are rarely considered, because the consequences will not appear until tomorrow. And other ministries and directorates than environment are

6. Nowt = nothing (Yorkshire dialect)

reluctant to modify the restrictive regulations until the consequences hit them directly.

But there is a current example where the consequences are arriving. The Commissioner of Agriculture and Rural Development recently realized that the EU has zero-tolerance for genetically modified feed grain in imports, if the variety is not approved for marketing in Europe. According to law, whole shiploads can be condemned if polluted by ever so little unapproved grain.

An assessment compared the impact of a two-year import interruption on the European agriculture, with an example of soybean under three different scenarios<sup>7</sup>:

1. EU-non-approved soybean is grown only in the US: the impact on the market will be low.
2. The GM soybean is cultivated also in Argentina: the impact will be medium cutting EU feed supply by 3.3 million tonnes and feed expenditure rising by 23 percent.
3. The soybean is cultivated in all three countries the US, Argentina and Brazil: the impact will be high, cutting EU feed supply by 25.7 million tonnes and feed costs escalating by 600 percent.

As Brazil is now exploring the large markets around the world, especially in Asia, the worst scenario is not unlikely. Possibly the Commission will have to consider the report's recommendations:

- Ensure flexibility in maintaining import, especially through avoiding asynchronous approvals of GMOs, which means accelerating the EU authorization procedures.
- Look into how to disregard the banning of imports containing minute amounts of GMOs approved in the exporting countries.

But whether they can find a way to avoid the existing legislation is a question for their lawyers.

Golden Rice is one important case study in how societies around the world are struggling to digest and manage new knowledge. It is not atypical; there are many situations of over-regulation, supported by ignorance, short-term calculations of trade effects and a deep failure to appreciate the strategic cost and significance of blocking research, innovation and investment. Knowledge and innovation are not necessarily popular—and those who may stand in greatest need sometimes have least influence on the debate.

---

7. *Economic impact of unapproved GMOs on EU feed imports and livestock production*. Report by the Directorate-General for Agriculture and Rural Development. July 2007.



# Can bioscience support agricultural progress in developing countries?

DR. IVAR VIRGIN

Agricultural biotechnology enables breeding systems to be more efficient and precise. It allows breeders to incorporate a range of new traits, improving productivity and quality characteristics of the crops. The technology is also scale independent. Therefore, biotechnology has large potential for increasing agricultural productivity, especially in the developing countries and also for small-scale farmers.

But the technology has been embraced very differently and there is a gulf between what it

can do and what actually happens in the South. This is largely due to a range of barriers, including weak public R&D capacity, stifling biosafety regulations, strict proprietary regimes and unclear policies. Agro-biotechnology is no magic bullet, and to play a role in improving world food security, these barriers must be overcome. Above all, there is need for visions what agro-biotechnology can do, coupled with strategies for how to get there.

## The scope for bioscience

Farmers will need to roughly double their production over the next 25 years to meet increased demand, as predicted by the Consultative Group of International Agricultural Research (CGIAR). Most would agree that a major part of this increased production has to come from improved crop productivity. To a large part, this productivity increase has to occur in developing countries, not least through improved crop varieties. Therefore, breeding institutions in developing countries have to be more efficient in serving farmers with new improved local varieties.

Breeding institutions all over the world are increasingly using biotechnology tools—genetic modification is only one of them (table 17)—

to more efficiently develop new crop varieties, and enhance them with desired qualities, such as:

- tolerance to floods, drought and frost;

*Table 17. The biotechnology toolbox is rapidly expanding, and genetic modification is only one on the list.*

- Molecular diagnostics
- Vaccine technology
- Tissue culture
- Molecular breeding and marker assisted selection (MAS)
- Genetic modification
- Structural/Functional genomics
- Bioinformatics
- Synthetic genomics

- tolerance to diseases and insect pests, thereby reducing the need for agrochemicals;
- higher efficiency in assimilating nutrients;
- improved nutritional characteristics and storage properties.

In theory, the biotechnology applications are scale independent. They would therefore be well suited to improve crops of key importance for small-scale farmers and supply them with a multitude of new improved crop varieties suitable for different agro-ecological conditions.

### The gene revolution

The implementation of effective agricultural strategies that can ensure food security in sub-Saharan Africa represents one of the most crucial development issues of our century. With its potential to speed up the introduction of improved crop varieties, agro-biotechnology is attractive to many developing countries. Comparing with the green revolution in the sixties, however, the conditions for adapting what can be called a “gene revolution” are entirely different. The green revolution was heavily subsidized by the governments and primarily implemented by the public sector institutions—the CGIAR and the national R&D systems. The markets were mostly domestic.

The current gene revolution—or “bioscience revolution”—is to a large extent driven by the multinational private sector, leading the development of a range of important crop traits. In parallel to the globalization of actors and markets, a large part of these new crop traits and technologies are also under strong intellectual property protection regimes.

In African countries, as in many other developing countries, there are two different seed delivery and crop production systems, existing side by side:

1. The market driven system, serving the com-

mercially-oriented farmers growing maize, soybean, oilseed rape, cotton, etc.

2. The informal or public driven system, serving the small-scale farmers, who grow crops with low profit margin, often vegetative crops, open pollinated varieties, and traditional grains.

It is unlikely that the private sector will play the leading role in the development of high quality varieties of the crops most relevant to the needs of the resource poor and vulnerable farmers. Unless there is investment in African public breeding institutions and agricultural support extension systems, the benefits of agro-biotechnology will have difficulties to reach resource poor small-scale farmers.

### Gene technology worldwide

The agro-biotechnology has been embraced very differently in various parts of the world (table 18).

North America has taken the lead. With its very strong public R&D and private sector, together with permissive policies and consumers in general accepting the technology, as much as 65 million hectares are planted with GM crops.

Also in Latin America, major areas are planted with GM crops, especially in Argentina, Brazil, Uruguay and Paraguay. There is a fairly strong or increasingly strong public R&D while the private sector mainly is composed by transnational companies. The policies are fairly permissive and like in North America, the consumers are on average accepting GM foods.

In Europe, the scenario is completely different. The public R&D and private sectors are not as strong as they used to be. The policies are prohibitive for the use of agro-biotechnology and consumers are on average sceptical. Consequently, the area planted with GM crop

Table 18. Adoption of GM crops in various parts of the world.

	Public R&D	Private sector	Area planted	Policies	Consumers
North America	Very strong	Very strong	Major (65 Mha)	Promotive/ permissive	On average accepting
Latin America	Strong in Brazil	Mostly TNCs	Major (36 Mha)	Promotive/ permissive	On average accepting
Europe	Strong?	Strong?	Minor	Precautionary/ prohibitive	Very sceptical
Asia	Strong	Getting stronger	Significant (10 Mha)	Permissive/ precautionary	Largely unaware
Africa	Getting stronger	Weak	Significant (1,8 Mha)	Cautionary/ permissive	Largely unaware

is minor, or even insignificant. To a large extent, countries in Europe, including Sweden, seem to have given this technology a miss.

Asia is steadily advancing its use of agro-biotechnology, currently with around ten million hectares planted with GM crops, mainly in India but also in China and the Philippines. The public R&D sector in Asia is fairly strong, and particularly strong in China. The private sector is also getting stronger, not least in India. Policies are permissive even though in some countries precautionary. The consumers are largely unaware of biotechnology.

In Africa, the public R&D sector is weak but getting stronger, while the private sector continues to be weak. Only South Africa is growing GM crops on a larger scale, but field trials are on their way in several African countries. The policies are what can be called cautionary. Countries in Africa are very aware of the GM controversy in Europe, but are at the same time influenced by the rapid adoption of GM crops in regions like Asia and Latin America. The public is largely unaware but there is a political will to use advanced agro-biotechnologies to improve crop productivity and strengthen the agricultural sector in the region.

In a way, this variation in policies and adoption rate of agro-biotechnologies is understanda-

ble as it is natural for different countries to have different policies according to their situations. It is essential, however, to understand that policies also have consequences for the ability of countries to use the advancement in modern biosciences to improve on their agricultural sectors.

### The barriers

Even though the applications of agricultural biotechnology are well suited to improve specific traits and crops of importance to small-scale farmers, bio-science hasn't yet made an eminent impact on world food security. In fact, there is a gulf between what agro-biotechnology can do in principle, and to what extent the technology has improved the situation for farmers in the South. To use agro-biotechnology as a tool for improving food security and crop productivity, a number of barriers has to be overcome. These include:

#### 1. Weak public R&D capacity

Only to a limited degree, the public breeding systems have been able to respond to the challenges facing the small-scale farmers. Important public research work is ongoing. Only in Africa, there are more than 15 R&D

technology projects targeting improved cassava, sorghum, maize, millet, cowpea, banana and other crops of importance for the small-scale farmers, using agro-biotechnology and in some cases also genetic modification.

But it is important to understand that the benefits are long-term, and that today's R&D efforts will take some time before they eventually reach the fields of small scale farmers. Investments in public R&D must also include investments in extension services and other mechanisms to improve the dissemination of improved planting material to small-scale farmers.

## 2. Biosafety regulatory challenges

The regulatory systems must not only be functional but also feasible and geared to promote innovation of local crops directed to small-scale farmers' needs.

Any biosafety regulatory system demands high-quality risk assessment data. This becomes a major hurdle for the public R&D sector, which does not have the experience or the resources to comply and pull GM crops through the regulatory system. Thereby potentially promising GM technologies developed by public R&D risk to be delayed or stuck in public sector labs.

The regulatory set-up must build credibility among the citizens without stifling the progress. One way is to maintain tough criteria, but to increase efficiency; the regulators could be required to share data and knowledge with risk assessment authorities in countries less experienced in using GM technology.

## 3. Proprietary regimes

More often than not, the output traits are cov-

ered by proprietary rights, which become barriers for the development. There is always room for negotiation, but to do that, the public sector needs the capacity to negotiate access to crop traits and technologies. Another alternative is that development institutions, such as the CGIAR, initiate an "open-source" approach, letting their technologies be freely used.

## 4. Unclear policies

The biotechnology policies play an extremely important role for the development of agricultural production. Clear biotechnology policies balance the risks against the benefits, and communicate this to the consumers and society. They also balance the rights between various actors.

## Way forward

Modern bioscience can contribute to improved crop productivity and food security in developing countries, and also in the process towards more sustainable agricultural systems. However, as mentioned, for the technology to deliver there are many hurdles and obstacles that need to be confronted. As a first step, the scientific community could play an important role in convincing a very sceptical audience, especially in Europe, that this technology has the potential to deliver.

There also need to be continuous discussions, coupled with visions and strategies, how agro-biotechnology can meet the local needs; how bio-resources innovation systems can be used as strategic tools for sustainable economic growth; and how bioscience can make production systems become more sustainable.

---

### Read more

*Agricultural biotechnology and small-scale farmers in eastern and southern Africa.* By Ivar Virgin *et al.* Published 2007 by Stockholm Environment Institute.



# Responsibilities for change

Appropriate science for an overpopulated planet, p 99

Extracts from the discussions, p 105



# Appropriate technologies for an overpopulated planet

PROF. CHRISTOPHER J. LEAVER

We live on an overpopulated planet. Today, the earth hosts 6.8 billion people and by 2050 we will be around 9 billion. The challenges we face during the next few decades demand *all appropriate agricultural technologies* to be used to sustain the predicted increase in population. One of them is genetic modification by marker assisted breeding and transgenesis where appropriate.

If the benefits of science are to reach those who need them most, there must be radical

changes in the way science is done and the way that biosafety regulations are implemented internationally.

We need a more participatory and multi-stakeholder approach towards setting priorities for the food security and nutrition crisis that is already acute. This must be rational and science-based, and led by political wisdom, based on joint consensus between ministries of health, agriculture, finance, environment and trade.

## The challenges

Today, humans appropriate about 30 percent of the terrestrial photosynthetic production and around 33 percent of the planet's land area for cropland and pasture.

*What portion of photosynthetic production or area for cropland is sustainable for humans to use, and how much do we need to share with other species? How can we optimize the usefulness and beneficial impact of agricultural harvests in the future?*

Many people in the urban developed countries live with a romantic vision of rural landscapes populated by healthy hardworking farmers producing good harvests. In reality, a significant and growing proportion of the world comprises malnourished people struggling to

exist by subsistence agriculture on marginal and depleted soils.

More than 850 million people<sup>1</sup>—more than the whole of the European Union and the United States together—go hungry every day. As many as 24,000 *die every day* from hunger and malnutrition. Most of the malnourished, around 650 million, live in rural areas. Two hundred million live in Africa.

*How can we deliver global food security, both calorific and micronutrients, to avoid predicted deficits as early as 2020? How can we deliver environmentally sustainable doubling of crop production by 2050?*

Due to the growing population; the rising wealth in many countries (with the associated

1. Between 2003 and 2005. Due to increased food prices, FAO estimates that in 2008 the underfed are closer to one billion.

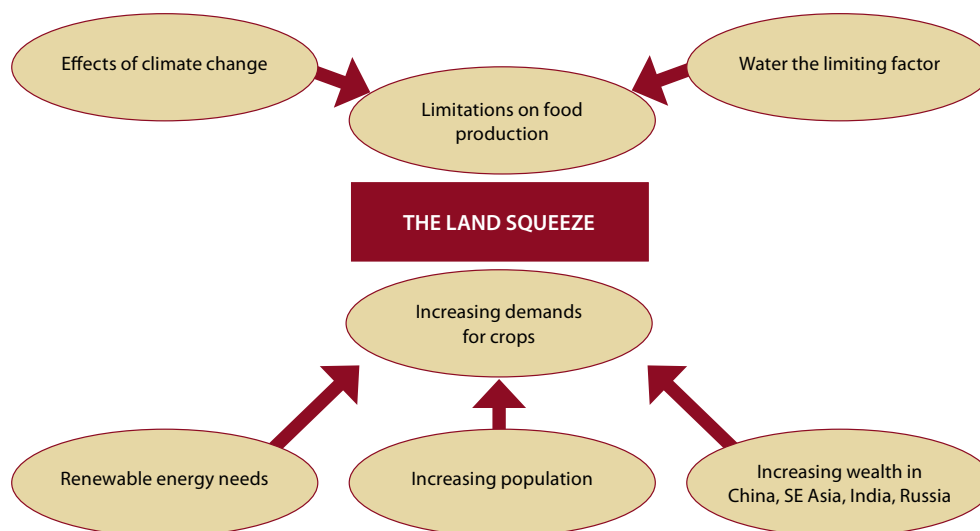

Figure 24. Farm land is a limited resource pressurized between increasing demands and limitations for its production capacity.

increase in consumption of calories and animal protein) and an emerging need for renewable energy, there is increasing demand for farm-land. At the same time, limiting factors such as climate change and water shortages are heightening the pressure on land suitable for agriculture (figure 24).

*How can we combat climate change, global warming and drought and ameliorate its impact on crop productivity? And how can we reduce our dependence on, and ultimately replace petrochemicals with renewable chemical feed stocks from plants?*

### Appropriate technologies

If future agriculture is to provide food security for the planet's burgeoning population, world food supply must be doubled by 2050. As the potential for land expansion is limited, most of

this increase has to come from land already in use. As a consequence, the technologies to look for are those that give yield increased outputs from reduced inputs.

Appropriate and further developed agricultural technologies will be required. These include:

- Integrated pest management.
- Reduction of chemical use.
- Water conservation.
- No-till practices.
- Precision agriculture.
- Conserving genetic diversity.
- Genetic modification by marker assisted breeding, and recombinant DNA technology where appropriate.

Gene technology is simply a set of new tools for crop improvement. It allows a more targeted predictable, precise and controllable genetic improvement of crops, and can be used in two

major ways: marker assisted breeding to develop better varieties faster; and recombinant DNA modification to introduce new traits into the plant (figure 25).

The reasons for undertaking genetic modification are:

1. To improve the efficiency of specific metabolic pathways in plants so as to improve the efficiency of the plants as a whole in terms of its yield, nutritional quality or agronomic characteristics.
2. To bypass some limiting factors such as intolerance to heat, cold or drought, to improve resistance to pests and diseases.
3. To change the nature of the harvested product—as a human foodstuff; to provide a therapeutic substance; or to provide industrial feed-stocks (e.g. biofuels and biodegradable polymers).

Theoretically one can take any gene from any organism, resynthesise it, put the appropriate regulatory control sequences at the begin-

ning and end of the gene, and insert it into a plant so that it is expressed at the correct stage of development in the correct tissue. Most of the genes—and introduced traits—we are interested in, will come from other plants. Figure 26 shows a variety of target traits which are currently being investigated.

The traits first introduced into crop plants were single gene traits that enhanced resistance to herbicides and insect pests. Today, crops are being produced with multi-genic introductions or stacked traits (putting two or three traits into the same plant) or as in Golden Rice, for example, introducing genes for enhanced provitamin A, iron and zinc accumulation into one plant. Current research is directed towards improving output traits, such as drought and salt tolerance or nutrient utilization, increasing the efficiency in plants in a way that we could not have achieved by conventional plant breeding alone.

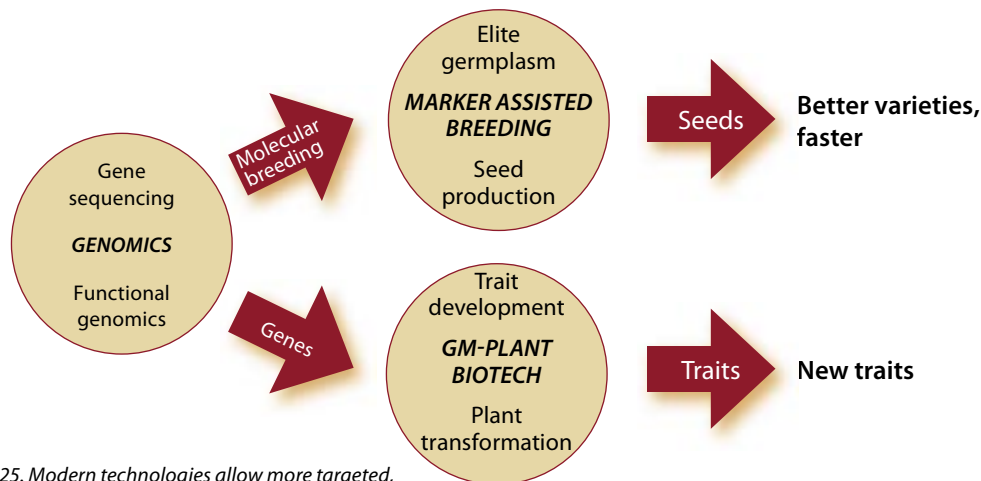

Figure 25. Modern technologies allow more targeted, predictable, precise and controllable genetic improvements of crops.

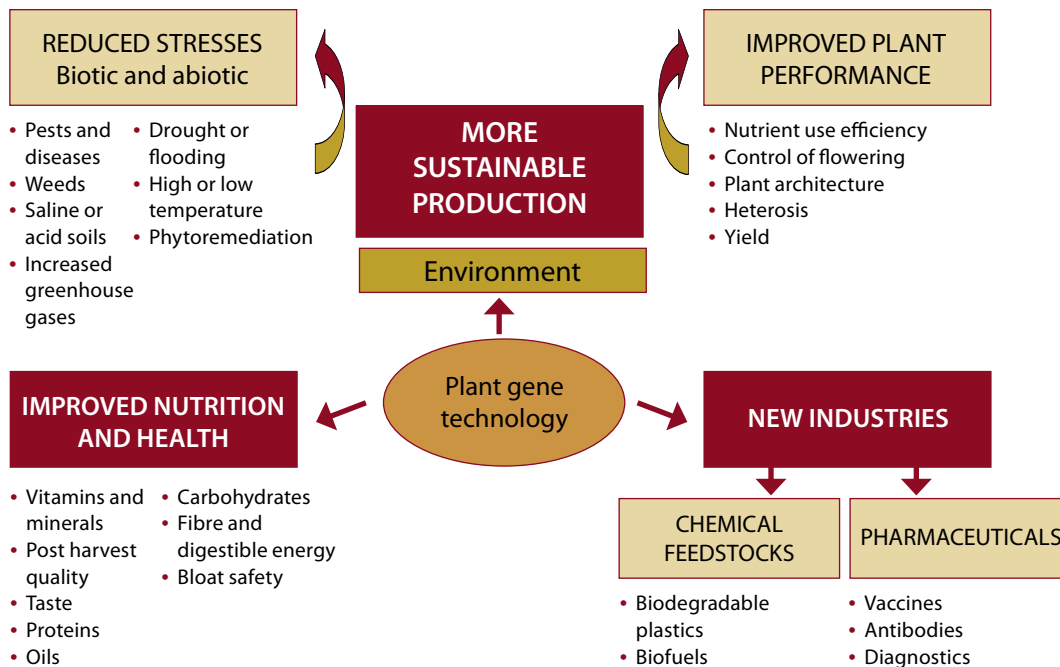

Figure 26. The targets for plant gene technology are manifold; the challenge is finding the genes for each trait.

### Biofortification of food for the poor

Malnutrition and dietary concerns exist all over the world, but differ between the poor and the rich (figure 27). Of the world's 6.8 billion people, 850 million are undernourished while 1.6 billion are overweight and 400 million suffer from obesity.

Deficiencies of vitamin A, zinc and iron are widespread in developing countries, where the staple foods lack sufficient quantities of these micronutrients. Together with other means of fortification, the vitamin A deficiency may be addressed with Golden Rice and other vitamin enhanced crops such as sorghum and sweet potato. Thereafter, one hopes that other micronutrient deficiencies will be addressed.

To date, biofortification research has concentrated on the enrichment of micronutrients

in staple foods like rice and maize. But there are also a tremendous number of local crops that play important parts in people's lives. Scientists are beginning to understand which genes underlie changes in metabolism, which will allow targeted increases in essential nutrients by genetic modification. Some future targets include improvements in the dietary composition of carbohydrates, proteins, lipids, vitamins and antioxidants.

### Opposition from the developed world

Agricultural biotechnology is a tale of great achievement, but also subject of continuing controversy. In spite of over two decades of vast experience and innumerable scientific official

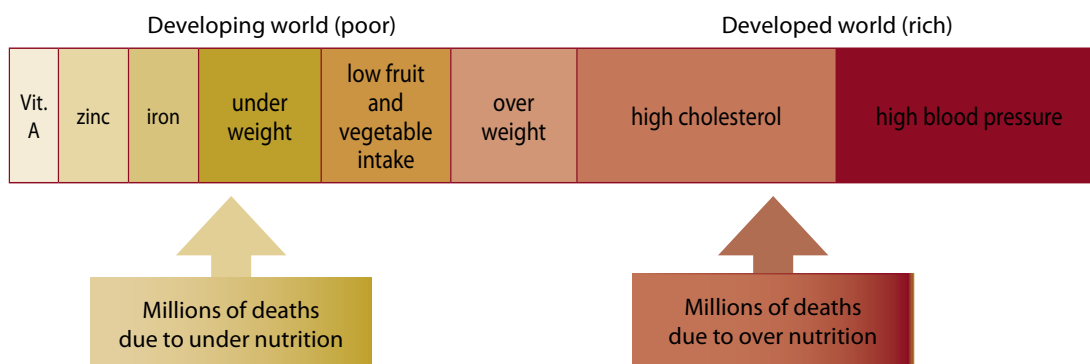

Figure 27. There is a strong link between diet and health for both the poor and the rich.

reports that have found no verifiable threats to human health or the environment; additional applications and wider diffusion of the agricultural biotechnology has been inhibited by opposition and costly inappropriate regulations.

One reason for the opposition being so strong is that the rich, well-fed, part of the world population have, until recently, not seen the need for increased food production, because of their access to safe, cheap food.

Another is that agricultural biotech has been one of the big success stories of activism. Not because it has stopped something unsafe, but because it has demonstrated the power of emotions over facts in policy making and innovation. For activists, single rights-issues such as biotechnology are used as part of a larger battle—fighting for social order, a world vision, moral leadership, etc. It is ironic that many of the DNA modified crop varieties, the development of which are being prevented or delayed, would lead to lower pesticide applications, higher yields, nutritional benefits, less CO<sub>2</sub> emissions and general environmental protection, of direct interest to those who oppose their deployment.

However, it is fine to be sceptical, and concerns about risks and social impact of science and technology should be heard. Because public acceptance can't be fought, it must be gained. And the politics must follow.

### A way forward

#### Scientists' duty of informing

Science may be value free but someone pays for it—it rests on popular support. Therefore, there is an obligation upon scientists to explain their science.

As there is no corresponding obligation upon anyone to listen, scientists have to make themselves heard. And as understanding is a war of attrition, they need to use a language that demands attention; the language of the people.

Scientists should see this as an opportunity, not just a duty.

#### Policies in line with science

Policy makers should keep in mind that the biosafety regulations and regulatory compliance must be brought in line with scientific evidence

“He who has bread may have troubles. He who lacks it has only one problem.”

*Byzantine proverb*

regarding risks and benefits, and reduce the costs of these procedures. Certain regulatory principles—such as keeping the degree of government scrutiny proportional to the perceived risk and regulating similar things in similar ways<sup>2</sup>—must be respected.

Not doing so means passing over this powerful agricultural innovation to big multinational agribusiness industries who can afford hugely expensive R&D and the cost of regulatory approval, while small and medium size enterprises, the public research sector and developing countries will be unable to take part in this emerging bio-economy.

#### Investing in science

To ensure future food security in a sustainable and environmental-friendly manner, we must double productivity on the same area of land and at the same time address the concern associated with modern high input agriculture, declining water availability and the threat of climate change.

The only realistic option is to invest in the science and technology necessary to increase the

efficiency of agriculture and attempt to reverse the impact of manmade climate change.

#### Using all appropriate technologies

We must fully evaluate the potential contribution of *all appropriate technologies*. This can be achieved by combining the best of conventional plant breeding with *marker assisted breeding* and *genetic modification*, to contribute to the security of future generations and deploy them where *appropriate*. A combination of chemical and biological solutions must be used.

#### Accepting that technology belongs to modern life

We cannot be technology and risk averse about food and farming, far beyond the rest of our daily life. Modern agriculture (including organic farming) is based on the accumulated technology of millennia including mutagenesis, plant breeding and the use of agrochemicals.

Doing nothing is not an option!

---

2. See also 'Achieving risk-based regulation: science shows the way', page 69.



## Extracts from the discussions

---

Each set of presentations was followed by a discussion. This section contains some extracts of discussion not fully covered in the presentations, edited to congregate. Mainly the discussions evolved around:

- Opposition and negative attitudes against GMOs.
- The future for biotechnology in Europe.
- The relevance of using biotechnology in developing countries, particularly in Africa.
- Changing policies to reflect scientific knowledge.

### Opposition and negative attitudes

There was an air of resignation and despair over the way the biotechnology has been treated for the last quarter of a century; how the situation has not changed over time and how the forces act to maintain status quo.

*Christina Glimelius*, Professor in Genetics and Plant Propagation at the Swedish University of Agricultural Sciences, suggested that from all trials and all work that have been done over the decades, the world must have learnt something.

– Twenty years have gone and there is no evidence of harm of growing or eating GMOs. But we still debate in the same way, and there is no agreement between us how to continue, she said.

*Mårten Carlsson*, former President of the Royal Swedish Academy of Agriculture and Forestry (KSLA), reflected that maybe agriculture hasn't always done its best.

– Starting with Rachel Carlsen's *Silent spring*, modern agriculture has many times been looked upon as a problem, with overuse of nutrition, pesticides and antibiotics. For a long time agricultural research was seen as a problem.

*Dan Belusa*, Greenpeace representative, posed the question why biotechnology hadn't yet showed immense results.

– There has been so much noise over so little, with only the herbicide resistant (RoundUp-ready) and insect resistant (Bt) crops in use, he said.

– The reason why you see only industrial GM crops is regulation, preventing this technology to be used by the public sector for public good, *Ingo Potrykus* replied. There are hundreds of fantastic inventions in laboratories around the world, not coming out because of regulation.

Ingo Potrykus described the function of NGO activity around the world, opposing genetic engineering.

– There is an immense, financially potent, self-repeating, self-interest feedback cycle of NGO activity around the world. Look at *www.gmobelus.com*, and get the real news about GMOs and biotechnology. When on the website, search for “NGO financing”, and all you want to know is there.

– I have met a lot of representatives of NGOs opposing GMO, he continued. And in private conversations they actually like Golden Rice and think it is a good idea. But the final response is always “I am sorry, although this looks very good, we are by principle against transgenic plants”.

*Adrian Dubock* added that the opponents know very well that if Golden Rice is successful, many arguments against GMO will be undermined.

*Bruce Chassy* concluded that unfortunately the scientists have been too quiet about explaining what the technology is all about, and what it actually does.

– There are invisible but large benefits of GMO that the consumers don’t see. There are enormous reductions in pesticide use, petroleum use, soil compaction and soil erosion with subsequently improved water quality.

## The future for biotechnology in Europe

The future for biotechnology in Europe was much discussed, as it seems rather bleak with students doing away with the subject, field trials torn up and scientists intimidated.

– I think Europe has just said goodbye to one of the key technologies of the century, *Peter Beyer* said gloomily. We are doing some research on *Arabidopsis*, but in general we have simply lost contact with the development.

– Our courses in biotechnology are not popular among Swedish or European students, *Christina Glimelius* verified. But students come from the African countries, with a wish to learn these techniques. They actually make these programmes survive.

On the question of how to bring about a change the European Union, *Mark Cantley* came up with two suggestions:

– First, there needs to be stronger coordination between the Directorates General at the European level and between the different ministries at the national level, with biotechnology coordination committees with teeth.

– Secondly, the scientific communities need to recognize that they must develop communication skills.

But apparently, the GMOs are already there.

– Wine, cheese and beer in Europe do contain recombinant ingredients, exclaimed *Gerard Barry*. But unlabelled, because they are processing aids. There are concerns about tomatoes containing a fish gene, but very soon the ice cream in Europe will contain a recombinant fish gene as an emulsifier stabilizing agent.

*Ake Bruce*, Professor at the National Food Administration in Sweden and Vice President of KSLA, agreed that there are a number of food additives produced by genetically modified microorganisms, for example citric acid and certain amino acids.

Ingo Potrykus mentioned having experienced a positive change when recently hearing from the British Environment Minister.

– After ten years of asking those who defend GMOs to present evidence that there is no harm, the opposition will now have to present proofs that there is harm, and they will get one year to show that, Ingo Potrykus referred to his saying.

### **The relevance of biotechnology for Africa**

Part of the discussion revolved around the role of GMO for resource-poor countries, in particular in Africa.

*Judi Wakhungu* described the food crisis Africa is just going through, how poor families have to pay three times more today for a bag of maize than one year ago.

– In the national perspective, we are looking for options to become more food secure, not to have to go through such a crisis again, she said, thereby indicating that food security may have priority over food safety.

*Inge Gerremo*, former Senior Adviser, Swedish International Development Cooperation Agency (Sida), suggested that biotechnology is important, but primarily for the future African agriculture as there are a number of basics that have to be tackled first.

Dan Belusa, Greenpeace, referred to Bruce Chassy's listing of the real killers, signifying the pressing needs for clean water and better food storage facilities.

– Accordingly, FAO doesn't say the world needs GMO. They say that we need basic infrastructure to really make an improvement of food security in Africa, he said.

– There are many problems, and GMOs will not solve all of those, Bruce Chassy replied. GMO is one piece of a complex puzzle, and too much has been made up of it. Genetic engineering is simply a different way of breeding seed that will perform a specific function. We can use all other technologies, so what's the problem with this one?

Adrian Dubock expressed that biotechnology in general is scalable and therefore very appropriate for developing countries.

– For conventional breeding, it takes some years to develop a new variety. If it wasn't for the regulatory burden, using GMO, new traits could be transferred into the established varieties quickly, and therefore there is potential to reduce costs. Genetic engineering definitely has a potential for small crops in poor countries, for societies that don't have much resources.

### **Changing policies to reflect scientific knowledge**

Over and again, the discussions landed in how to bring about a change, achieving science-based political decisions and policies, and how to reach out with scientific findings to the public and the politicians.

Most opinions reflected the need for science-based policies. Only *Peter Sylwan*, science journalist and professor, questioned the logic in that.

– You talk about policies being science-based, he said. But is that what politics is about? Isn't politics also value-based? What conclusions should scientists draw from the standpoint that politics is not science-based but value-based?

And he continued:

– To have science-based politics, you need to make science valuable. That is totally about context and content and telling good stories.

– It is appropriate to have political discussions about at which age you are allowed to drink alcohol or drive a car. But it is not appropriate to debate whether a whale is a mammal or a fish, or whether the earth is flat, *Henry Miller* stated impatiently.

Another issue was to which extent the politicians should listen to public concerns.

– Politicians are elected to make decisions on behalf of the populations, and not to follow the main headlines, Adrian Dubock said.

*Matin Qaim* agreed and meant that politicians have to be careful with for example strict regulations as they can work both ways.

– It is not only that regulations reflect the public opinion, but also that the public, seeing all the regulation, may believe that if something is regulated so toughly it has to be dangerous, he said.

The core issue seemed to be how to reach out with scientific findings, causing a lot of debate and some resentment. The urgency of the matter was well described by Bruce Chassy.

– We don't know how many people have died so far because we haven't done what we would have if Golden Rice had been a conventional crop. We are talking about holocaust dimensions, millions of people. This is not a joke.

Ingo Potrykus reiterated how much public funds NGOs like Greenpeace receive for public information, in comparison to scientists, who get none for that purpose.

– The access to money for informing the public and politicians is very unbalanced, he said. A public relations campaign may cost EUR 500 million, money that NGOs have against zero on the side of the scientists.

– It is wonderful to hear the opposite side, Dan Belusa, Greenpeace, interjected. Because you have a 180 degree view of my normal impression of politics favouring GMO and all money going to promoting GMO.

– But communication is not only about money, *Annika Åhnberg*, former Swedish Minister of Agriculture, countered. There are examples of huge amounts of money put into communicating issues that still are lost. What you need is strong convinced individuals and getting the message out at the right point at the right moment.

– Being a journalist and knowing how popular responses may be, I must say that people don't look at NGOs and regulations the way you scientists do, said Peter Sylwan. People perceive the NGOs as protection against the scientists. Therefore, when you ridicule Greenpeace, the public perception is that you are ridiculing them and their fears.

– Journalists have professional jobs to do, Henry Miller opposed. And if they, in the interest of balance, quote Ingo Potrykus and one of these Greenpeace people, that is not balance. That is poor judgement of the journalist.

Possibly this difference in opinion merely reflects a cultural difference between Americans and Europeans, as interposed by Bruce Chassy:

– Surveys about people's trust in sources for information on biotechnology in the EU and the US, have shown that in the EU consumer groups and environmental groups occupy the top two trusted sources of information, while in the United States they are at the bottom of the trusted list, he said.

Henry Miller referred to his book *The Frankenfood myth*, giving six steps of action to achieve science-based policies:

- First, scientists must actively protest on policies and regulation to be revised into a scientifically defensible approach. Second, scientific institutions must stimulate public discourse. Third, media must discount bogus science. Fourth, the biotechnology industry itself must advocate scientific regulatory policies. Fifth, all stakeholders should promote science-based public policy. And sixth, we need to rethink the governments' monopoly over regulation.

- We scientists have the political responsibility to explain to the public that their attitude towards GMO is completely wrong, Ingo Potrykus agreed. We need politicians not just looking for whether they are losing or gaining, they must take up their responsibility to tell the public what they know is right and what is wrong.

Annika Åhnberg did not agree but threw the ball back to the scientists.

- What is always needed for politicians is knowledge, which they obviously haven't got. Therefore, there must be something wrong with the way scientists try to communicate with them. Remember that there is only one person in the whole world that you can change and that is yourself, and the way that you communicate.

Given the fact that Annika Åhnberg was the only high-level politician, though former, she was asked the question on how to reach the politicians. She replied that one has to try to understand what it is to be a politician.

- Sit down on a chair and picture yourself as the minister of agriculture, and try to understand what kind of information you would be looking for, she said. Try also to understand that in democracies, politicians have to listen to their voters, to the people. If people are worried about GM, politicians have to worry, too. But if politicians really have the information and knowledge they need, they are able to stand up and argue for something they really believe in. But as long as they lack the information that you scientists have, but have not delivered, you leave them without the tools.

- My experience is that scientists do excellent work, Annika Åhnberg concluded. Then you place it in a drawer and do nothing. You scientists have to bring your good ideas to the politicians, making them aware of your findings.

## Acronyms and definitions

<b>Biofortification</b>	For many years, industry has fortified foods to improve the nutritional status of people. A well known example is iodized salt. Biofortification means asking the plant to produce and provide the missing micronutrient, through conventional breeding or recombinant DNA modification.
<b>Bt</b>	<i>Bacillus thuringiensis</i> , a common soil bacterium that produces crystals containing proteins (called cry toxins) toxic to certain insects, e.g. from the orders of Lepidoptera (moths and butterflies), Diptera (flies and mosquitoes) and Coleoptera (beetles). The bacterium was discovered in 1901 and is used as a biological insecticide and in genetically modified crops.
<b>The Cartagena Protocol on Biosafety</b>	An international agreement governing the transboundary movements, handling and use of living modified organisms resulting from modern biotechnology (i.e. GMOs). Adopted in 2000, as a supplement to the Convention on Biological Diversity.
<b>DNA</b>	Deoxyribonucleic acid, containing the genetic instruction used by all known living organisms.
<b>Endosperm</b>	The specialized storage tissue of seed, providing nutrients for the plant embryo in the form of starch, oil or protein, and therefore an important part of human diet. The rice endosperm is the polished grain.
<b>GM</b>	Genetically modified
<b>GMO</b>	Genetically modified organism (see recombinant DNA modification).
<b>NGO</b>	Non governmental organization.
<b>Provitamin A</b>	Also called beta-carotene or $\beta$ -carotene; the chemical substance that the human body can convert into vitamin A.
<b>R&amp;D</b>	Research and development.
<b>Recombinant DNA modification</b>	Breeding through genetic engineering, moving pieces of DNA reading for specific genes into another organism, thereby giving it novel genes. Several terms are used describing the technology and its products. The correct term is recombinant DNA modification, but the more popular term genetic modification or its short form GM is understood as the same thing. Similarly genetically modified organism (GMO) in this publication bears the same meaning as the more precise term recombinant DNA modified organism, and GM crop means genetically modified crop, or correctly recombinant DNA modified crop. In this publication, these terms are used in accordance with each speaker's habit.
<b>VAD</b>	Vitamin A deficiency.

## Speakers' profiles



**Ingo Potrykus** is the Chairman of the International Humanitarian Golden Rice Board, and Professor Emeritus of Plant Sciences at the Swiss Federal Institute of Technology (ETH) in Zürich. Prof. Potrykus is member of several academies including the prestigious Pontifical Academy of Sciences. He has honorary PhDs from Uppsala and Freiburg and has received numerous international awards. Since early 1970s, he has focused on development and use of genetic engineering technologies with crop plants with the goal to contribute to food security in developing countries. The best known example is Golden Rice, genetically engineered to combat vitamin A deficiency in rice-dependent poor societies. He, together with his partner Peter Beyer, did not shy away from taking responsibility for advancing this academic breakthrough across the numerous hurdles of product development and deregulation. Thirteen tough years after proof-of-concept, Golden Rice will finally reach the needy in Southeast Asia. The peers of *Nature Biotechnology* voted him, together with Peter Beyer, “the most influential scientist in the area of agricultural, industrial, and environmental biotechnology for the decade 1995 to 2005”, and *TIME Magazine* devoted him a cover in July 2000.



**Dr. Parminder Virk** is Senior Scientist in plant breeding at the International Rice Research Institute (IRRI) in the Philippines since 1999. Before that, Dr. Virk was Research Fellow at the University of Birmingham. He received his BSc at the Guru Nanak Dev University and MSc and PhD in plant breeding at the Punjab Agricultural University. Dr. Virk received the Crop Improvement Society of India Award in 1993, and has published 40 research papers in peer reviewed journals and one book. He has developed several rice varieties released to farmers in Asia and is member of the Genetical Society of Great Britain, Crop Science Society of America.



**Dr. Adrian Dubock** is owner and consultant of the Agricultural Consultancy for Development GmbH, bringing commercial approaches to public sector programmes in agriculture. He is also founding member of the Humanitarian Board for the Golden Rice Project. For 30 years (1977–2007), Adrian Dubock worked for Syngenta (previously ICI and Zeneca), including positions as the General Manager Central America (ICI), the Head of Marketing Asia, Africa, Australia (Zeneca), the Head of Mergers and Acquisitions, Ventures and Licensing (Syngenta) and the Head of Biotechnology Collaboration and Technology Donations (Syngenta). Scientific Fellow of the Zoological Society of London. Dr. Dubock is the architect behind the Golden Rice public-private partnership. He has written more than 50 articles, papers and contributions to books.



**Peter Beyer** is Professor at the Department of Cell Biology at the Centre for Applied Biosciences, University of Freiburg. Prof. Beyer is the author of about 100 original research articles and, together with Ingo Potrykus, the co-inventor of Golden Rice. Voted, together with Ingo Potrykus, the most notable personality in the areas of agricultural, environmental and industrial biotechnology by readers of *Nature Biotechnology* on the occasion of the journal's 10<sup>th</sup> anniversary. Member of the Golden Rice Humanitarian Board. Currently Principal Investigator on a rice project, including Golden Rice, supported by the Bill and Melinda Gates Foundation under the umbrella of their 'Grand Challenges in Global Health' programme.



Dr. **Gerard Barry** is the Golden Rice Network Coordinator at the International Rice Research Institute (IRRI), the Philippines. Since 2003, also the HarvestPlus Rice Crop Team Leader and Leader of IRRI's Programme 4: Rice and Human Health. Head of IRRI's Intellectual Property Management Unit. Prior to joining IRRI, Gerard Barry spent more than 20 years with Monsanto Company in the US, where he had various positions, including the Co-Head of the Rice Business Team, the Head of the Rice Genome and Rice Genomics projects, and the Director of Research for developing country operation. Dr. Barry is the co-inventor on 20 patents, co-author of more than 50 research articles, and a frequent speaker at conferences.



**J. V. Meenakshi** is Professor at the Department of Economics of Delhi School of Economics, University of Delhi, India. Earlier, she was the Impact and Policy Coordinator, HarvestPlus, International Food Policy Research Institute, Washington, D.C. She obtained her MSc and PhD degrees in agricultural economics at Cornell University. Dr. Meenakshi has published widely in the areas of the economics of biofortification, poverty and welfare, food insecurity, food demand and agricultural markets.



**Matin Qaim** is Professor at the Department of Agricultural Economics and Rural Development, University of Göttingen, Germany. From 2004 to 2007, Matin Qaim was Professor of Agricultural and Development Economics at the University of Hohenheim in Stuttgart, before taking on his current position in Göttingen. Prof. Qaim has published widely on socioeconomic aspects of agricultural biotechnology in developing countries. His research has been awarded with national and international academic prizes. He is adviser for various international organizations and projects related to international agricultural development and food security.





**Robert Paarlberg** is Betty Freyhof Johnson Class of 1944 Professor of Political Science at Wellesley College, Massachusetts, and Associate at the Weatherhead Center for International Affairs at Harvard University. He has served as visiting professor of government at Harvard, as a legislative aide in the US Senate, and as an officer in the US Naval Intelligence Command. Prof. Paarlberg is member of numerous boards and networks, and is the author of various publications, the latest well-known *Starved for science; how biotechnology is being kept out of Africa*, published in 2008 by Harvard University Press.



**Bruce Chassy** is Professor of Food Safety and Professor of Nutritional Sciences at the University of Illinois Urbana-Champaign. Prior to that, he served as Head of the Department of Food Science and Human Nutrition at the University of Illinois. Prof. Chassy's research focused on genetic modification of microorganisms for food and dairy fermentations, which lead to an interest in strategies for food safety evaluation and their application to the setting of public policy. He has served on several national and international boards and committees, such as the ILSI Biotechnology Task Force, Chair of the Institute for Food Technologists Expert Panel on Food Safety and Nutrition, FDA Food Advisory Committee, WHO/FAO Joint Consultation on Food Derived from Biotechnology and the EPA FIFRA Scientific Advisory Panel.



**Dr. Henry Miller** is Research Fellow at the Hoover Institution, Stanford University in the US. From 1979 to 1994, he served at the Food and Drug Administration (FDA) in a number of posts, among them Special Assistant to the FDA Commissioner and Founding Director of the FDA's Office of Biotechnology. Dr. Miller is affiliated with several think tanks and is the recipient of numerous awards and prestigious lectureships. He has published extensively in a broad spectrum of publications. One of the later, *The Frankenfood myth: how protest and politics threaten the biotech revolution*, published in 2004 by Praeger Publishers, by Barron's selected as one of the 25 best books of 2004.



**Prof. Judi W Wakhungu** is the Executive Director of the African Centre for Technology Studies (ACTS) in Kenya. Previously she was Associate Professor of Science, Technology and Society at Pennsylvania State University where she also served as the Director of Women in Science and Engineering (WISE) Institute. Prof. Wakhungu has served on many boards and committees, both nationally and internationally. These include Co-Chair of the International Assessment of Agricultural Science and Technology for Development (IAASTD), Scientists Without Borders, the Lemelson Foundation, and the World Bioenergy Association.



Mr. **Mark Cantley**, now semi-retired, was until 2006 Adviser in the Directorate for Biotechnology, Agriculture and Food, of the Directorate-General for Research, of the European Commission. Prior to that he spent six years as the Head for the OECD's Biotechnology Unit in the Directorate for Science, Technology and Industry, after having been with the European Commission since 1979, originally as a member of the futures group Forecasting and Assessment in Science and Technology (FAST) and from 1984 to 1992, as the Head of the Concertation Unit for Biotechnology in Europe (CUBE). Mr. Cantley has written extensively for professional and general publications.



Dr. **Ivar Virgin** is Senior Researcher at Stockholm Environment Institute (SEI) in Sweden. From 1993 to 1994, he pursued a Postdoctoral Fellowship at the Institute für Genforschung (IGF) in Berlin on genetic modification of crops for producing biodegradable packaging material. Ivar Virgin has published extensively in the area of agricultural biotechnology, technology transfer, cost/benefits of agricultural biotechnology, food safety, biosafety risk assessment and biosafety capacity building in developing countries. Dr. Virgin has also developed and is managing the Swedish International Development Cooperation Agency (Sida) supported 'East African regional programme and research network for biotechnology, biosafety and biotechnology policy development', BIO-EARN ([www.bio-earn.org](http://www.bio-earn.org)).



**Christopher J. Leaver** is Professor Emeritus, from 1990 to 2007 the Sibthorpe Professor and Head of Department of Plant Sciences at the University of Oxford. Since 2002 Visiting Professor of the University of Western Australia. Member of the Science and Technology Advisory Board to the main Board of Syngenta; Trustee of the John Innes Foundation; and Governing Body Member of the John Innes Centre in Norwich. Prof. Leaver is member of several academies, including the Academia Europaea, and has been awarded with numerous international prizes and memberships. He has published more than 150 scientific papers in international journals. Christopher J. Leaver is strongly committed to creating dialogue and informing on public understanding of science.

## **Utgivna nummer av Kungl. Skogs- och Lantbruksakademiens TIDSKRIFT (KSLAT)**

(Titlar markerade med \* publiceras endast elektroniskt på KSLAs hemsida [www.ksla.se](http://www.ksla.se))

### **2006**

- Nr 1 Jakten på den gröna marknadskraften\*
- Nr 2 Turismen – en grön framtidsnäring\*
- Nr 3 När är det kokta fläsket stekt? – om risker och nytta med upphettning av mat
- Nr 4 Verksamhetsberättelse 2005 Kungl. Skogs- och Lantbruksakademien
- Nr 5 Ädellövskog för framtiden
- Nr 6 Situationen i Sveriges hav och arbetet mot övergödning\*
- Nr 7 Det ekologiska valet – påverkar det nästa generations hälsa?
- Nr 8 Water Framework Directive – WFD Implementation in a European Perspective\*
- Nr 9 Klimatet och skogen – underlag för nationell forskning
- Nr 10 Avian Influenza\*
- Nr 11 Socker i global handel, jordbruk och folkhälsa\*

### **2007**

- Nr 1 Water and Agriculture
- Nr 2 How to estimate N and P losses from forestry in northern Sweden
- Nr 3 Certifierad kvalitet från jord till bord\*
- Nr 4 Skogsskötsel för en framtid\*
- Nr 5 Valuable Agricultural Landscapes – the Importance of Romania and Scandinavia for Europe
- Nr 6 Verksamhetsberättelse 2006 Kungl. Skogs- och Lantbruksakademien
- Nr 7 Future Challenges for Reindeer Herding Societies\*
- Nr 8 Klimat och miljö i förändring – varifrån ska vi ta vår mat?\*
- Nr 9 Success Stories of Agricultural Long-term Experiments
- Nr 10 Den beresta maten – matens kvalitet i ett globalt perspektiv

### **2008**

- Nr 1 Verksamhetsberättelse 2007 Kungl. Skogs- och Lantbruksakademien
- Nr 2 Fiskets kollaps utanför Nordamerika – vad kan Sverige och Europa lära?
- Nr 3 Edens lustgård tur och retur – framtidsvägar till ett hållbart naturbruk
- Nr 4 Utveckling av den svenska resursbasen för internationellt skogligt arbete
- Nr 5 Skogens roll i ett framtida globalt klimatavtal
- Nr 6 Jakten på den gröna marknadskraften – del 2\*
- Nr 7 Golden Rice and other biofortified food crops for developing countries – challenges and potential

Among humanity's largest challenges is how to come to grips with poverty and starvation, and how to feed the growing world population. As many as 24,000 people die every day of starvation and malnutrition, to a large extent because of micronutrient deficiencies. One of the most serious is vitamin A deficiency (VAD).

Already in 2002, it was possible to biofortify rice with beta-carotene, from which the human body synthesizes vitamin A. But the crop is still not in the fields of the farmers, because the rice is genetically engineered. After solving the issue of the patents making the rice freely available, there has been a whole range of obstacles, which so far have delayed the launching of this Golden Rice by about ten years, compromising the lives of millions.

The main focus of this report from the Bertebos Conference 2008, is on Golden Rice and other genetically modified and biofortified crops, on the potential they have for the world population, and on which challenges have to be overcome before they can be used. Of all priorities, the highest urgency is for the poor in the developing countries.



### **Royal Swedish Academy of Agriculture and Forestry**

Visiting address Drottninggatan 95 B, Stockholm  
P. O. Box 6806, S-113 86 Stockholm, Sweden  
tel +46 (0)8-54 54 77 00, fax +46 (0)8-54 54 77 10  
[www.ksla.se](http://www.ksla.se), [akademien@ksla.se](mailto:akademien@ksla.se)

The Royal Swedish Academy of Agriculture and Forestry (KSLA) is a meeting place for the green sector. The Academy is a free and independent network organisation working with issues relating to agriculture, horticulture, food, forestry and forest products, fishing, hunting and aquaculture, the environment and natural resources, and with agricultural and forest history. We work with issues that concern all and interest many!